

XTR2

USER MANUAL



No Climb Products Ltd.
163 Dixons Hill Road, Welham
Green, Hertfordshire, AL9 7JE,
United Kingdom
Tel +44 (0)1707 282 760

EU: shift-consult Hubert Scherzinger
Hessenweier 9,79108 Freiburg, DE
Tel: +49 (0) 7665 91 21 74

detectortesters.com

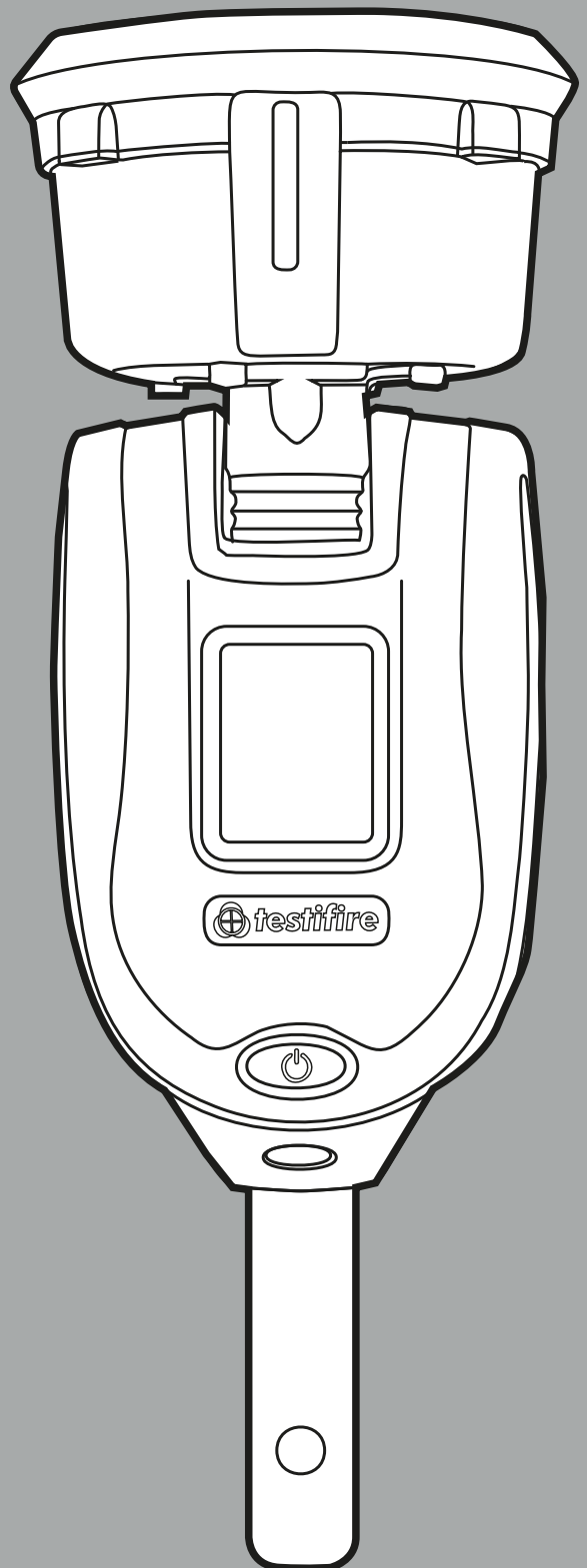

UK
CA



CAUTIONS & WARNINGS

Warning

This product is intended to be used at height.

Exercise great care and always wear appropriate PPE (personal protective equipment) when operating above head height in order to avoid the risk of injury.

DO NOT OVER REACH. Keep proper footing and balance at all times. Proper footing and balance enables better control of the equipment in unexpected situations.

Pay particular attention to avoid contact with overhead items such as light fittings, overhead power cables and any other objects that could be accidentally dislodged which might cause danger to the operator or anyone else in the vicinity.

Avoid prolonged, direct exposure to the vapour generated by XTR2. Safety Data Sheets for the XTR2 battery pack and XTR2 Smoke Cartridge are available. It is recommended to review the safety data sheets for XTR2

Battery Pack and XTR2 Smoke Cartridge before use (see detectortesters.com).

This product contains hot parts.

DO NOT TOUCH the heat element. It may be very hot immediately after use and may burn if touched.

Contains precision parts which may be easily damaged and cause injury. **DO NOT TOUCH** the smoke fluid intake pipe in the smoke cartridge area or the heat element in the tester cup.

Caution

Contains Lithium Ion rechargeable batteries:

- Do not dismantle, open, shred or incinerate batteries.
- Do not expose batteries to heat or fire. Avoid storage in direct sunlight.
- Do not short-circuit a battery. Do not store batteries loose in a box or drawer where they may short-circuit each other or be short-circuited by other metal objects.
- Do not subject batteries to mechanical shock.
- Keep batteries clean and dry.
- Do not use any charger other than that specifically provided for use with the equipment. Refer to the manufacturer's instructions or equipment manual for proper charging instructions.
- Do not leave a battery on prolonged charge when not in use.
- Do not use any battery which is not designed for use with this equipment.
- Do not use the battery in any other application.
- Keep batteries out of the reach of children.
- Dispose of properly.

THE FOLLOWING SYMBOLS ARE USED THROUGHOUT THIS USER MANUAL AND ON THE PRODUCT:



This symbol on the product indicates that there is a safety hazard or an operation requiring care to avoid damage to the product or environment. You must read the appropriate sections of the User Manual to understand the nature and severity of all the potential hazards present and the action you must take.



This symbol on the product warns you of hot surfaces or heat by convection.



This symbol on the product indicates that you should read and understand this User Manual before using this product.



This symbol on the product indicates that this part of the device is susceptible to static damage.



To comply with WEEE (Waste Electrical & Electronic Equipment) Regulations the crossed out refuse container symbol on this product or literature indicates that it should not be disposed with other business waste at the end of its working life. To help ensure that valuable resources are reused and recycled, and to prevent possible harm to the environment or human health from uncontrolled waste disposal, please separate this from any other types of waste.

IMPORTANT INFORMATION

- Read this User Manual completely before using your XTR2
- Keep this User Manual - save all safety and operational instructions for future reference.
- Take note of the Warnings - Read carefully and follow all warning labels on the product and those described in this User Manual.
- XTR2 is electronic test equipment and care should be taken when handling and storing. Dropping the unit on to a hard surface could damage it. Please look after it, treat it with care for lasting use.
- This product is designed for indoor use only and should not be subject to harsh environments. It is not designed for use in hazardous areas (those containing explosive vapour or dust). Do not use the equipment in places where temperatures and/or humidity are high or go through rapid changes including:
 - Direct sunlight
 - Near heat sources (stoves, radiators, etc.)
 - Sandy or dusty environments
 - In the presence of strong magnetic fields
 - Places prone to strong vibration
 - Restrictions detailed in the Technical Information (see Section 12).
- XTR2 may be used in ceiling and floor voids but care must be taken to ensure that the unit and cup can pass through gaps in both directions.
- Stop using XTR2 immediately if you notice any damage or unusual odours, liquids or sounds coming from the unit. Turn the power off immediately and consult technical support and troubleshooting (see section 11).
- Use only approved accessories as described in this manual that are recommended by the manufacturer for your XTR2 (see section 7).

KIT CONTENTS WHAT'S IN THE BOX?

- XTR2 x1
- XTR2 smoke generator x1
- TES3 smoke cartridge x1
- XTR2 battery pack x1
- Battery charge cradle x1
- Mains power supply x1
- Car power adaptor x1
- Charger lead (USB-C to USB-C) x1
- Quick start guide

CONTENTS

	Cautions and warnings	2
	Important information	3
	Kit Contents – What’s in the box?	3
1.	General Instructions	6
	1.1 Warranty	6
	1.2 Acknowledgement	6
	1.3 Recycling	6
	1.4 Declarations & Certifications	6
	1.5 Privacy Policy	6
2.	XTR2 Introduction	7
3.	Preparation for first use	8
	3.1 Getting started with DT Connect	8
	3.2 Charging the Battery	9
	3.3 Installing the Generator	9
	3.4 Inserting the smoke cartridge	10
	3.5 Inserting the Battery	10
4.	Using XTR2	11
	4.1 Attaching XTR2 to Solo Access Poles	11
	4.2 Powering on XTR2	11
	4.3 LED Indicator Reference Chart	12
	4.4 Adjusting the Head Unit Angle	12
5.	Performing a Test	13
	5.1 Default Smoke Test	13
	5.2 Heat Test	14
	5.3 Combined Test	15
	5.4 Sequential Test	16
	5.5 Clearing a Detector	17
	5.6 Delayed Start	17
	5.7 Using the LED Torch	17
	5.8 Manual Purge	18
	5.9 Device Settings	18
6.	ASD Adaptor – Testing ASD Systems and Flat Detectors	19
	6.1 Testing an ASD System or Flat Detector	19
	6.2 Installing the ASD Adaptor	19
	6.3 Testing with the ASD Adaptor	19
7.	Removing and Replacing Consumables	20
	7.1 Removing the Smoke Cartridge	20
	7.2 Replacing the Smoke Cartridge	20
	7.3 Removing the Smoke Generator	20
	7.4 Replacing the Smoke Generator	21
	7.5 Removing the Battery for Charging	21
	7.6 Replacing the Battery	21
	7.7 Removing and Replacing the Membrane	21
8.	DT Connect App: Getting Started	22
	8.1 Downloading the App	22
	8.2 Signing in	22
	8.3 Pairing your XTR2	24
	8.4.1 Device Membership	25
	8.4.2 Membership Visibility in the App	25
	8.4.3 Free vs. Premium App Features	26
9.	DT Connect App: Job Creation	27
	9.1.1 Test a New Site	27
	9.1.2 Creating the Fire Panel Asset (Premium)	28
	9.2.1 Test and Existing Site (Premium)	29
	9.2.2 Site Asset List	30
	9.2.3 Asset Selection	30
10.	DT Connect App: Floor Walk Screen	31

	10.1.1	Floor Walk Screen - Premium Devices	31
	10.2.1	Changing Test Mode	32
	10.2.2	Manual Clearing	32
	10.3	Filter	32
	10.4	Changing Alarm Detection Mode	33
	10.5	Reconnect Your Device	33
11.		DT Connect App: XTR2 Test Result Capture	34
	11.1	XTR2 Test Result Capture	34
	11.2.1	PASS Result - Free Devices	34
	11.2.2	PASS Result - Premium Devices	35
	11.3.1	FAIL Result - Free Devices	36
	11.3.2	FAIL Result - Premium Devices	37
	11.4.1	ABORTED Result	38
	11.4.2	ABORTED Result - Free Devices	38
	11.4.3	ABORTED Result - Premium Devices	39
	11.5.1	Using Delayed-Start Test Mode	40
	11.5.2	Manual Result Selection	41
	11.5.3	Delayed Start Result - Premium Devices	42
12.		DT Connect App: Manual Asset Creation	43
	12.1	Manual Asset Creation	43
13.		DT Connect App: Managing and Deleting Assets	44
	13.1	Delete Test Result for Re-testing	44
	13.2.1	Delete Asset	44
	13.2.2	Delete Panel Asset	44
14.		DT Connect App: Existing Asset Testing	45
	14.1	Manual Test Result	45
	14.2	Test with XTR2	45
15.		DT Connect App: Job Completion	46
	15.1	Job Completion	46
	15.2	Panel Reconciliation	47
	15.3	Signature Collection	48
	15.4	Completed Jobs	48
	15.5	View Historical Job Summary	49
	15.6	Share Test Job	50
16.		DT Connect App: App Settings	51
	16.1	App Settings Menu	51
	16.1.1	Edit Profile	51
	16.1.2	My Companies	51
	16.1.3	Change Email Address	51
	16.1.4	Change Password	51
	16.1.5	Error History	51
	16.1.6	Push Notifications	51
	16.1.7	Vibration/Sound	51
	16.1.8	Help	51
	16.1.9	Give Feedback	51
	16.1.10	Terms and Conditions	51
	16.1.11	Privacy Policy	51
	16.1.12	Deactivate Account	51
17.		Consumables and Accessories	52
18.		Troubleshooting	53
	18.1	Device Error Codes	54
19.		Support & Technical	55
	19.1	Maintenance	55
	19.2	Technical Information	56
	19.3	Support Contact	57
		EU Declaration of Conformity	58

GENERAL INSTRUCTIONS

1.1 Warranty

In addition to any other express warranty given in writing by the Company in relation to the Goods, the Company warrants that the Goods supplied under these terms and conditions will be in accordance with the specification (if any) contained in the Purchase Order, and will be free from defects in workmanship and material for a period of 24 months (device and charger) from the date of delivery to the Buyer, or for a period of 24 months after the date of sale by the Buyer to the final customer, or for a period of 24 months from the date of first registration with DT Connect, whichever period is the shorter.

1.2 Acknowledgement

Testifire™ is a registered trademark of No Climb Products Ltd. All other brand names mentioned are trademarks or registered marks of their respective holders, and are hereby acknowledged.

©2023 No Climb Products Ltd.
All Rights Reserved.

1.3 Recycling

The packaging can be easily separated into the following materials:

- Cardboard (outer box)
- Cardboard (inner buffers, boxes)
- Polyethylene
- Plastic

Please dispose in line with local environmental requirements.

WEEE (Waste Electrical & Electronic Equipment) Regulations

XTR2, accessories and batteries are suitably marked to be recycled in accordance with your local environmental requirements. Alternatively, these items may be returned to the manufacturer via your reseller for disposal in compliance with WEEE (Waste Electrical & Electronic Equipment) Regulations.

1.4 Declarations & Certifications

This product and its associated components are fully compliant with the following:

- CE (including EMC, LVD and RoHS)
- UKCA
- 2014/53/EU – Radio Equipment Directive (RED); Articles 3.1, 3.2 and 3.3
- 2011/65/EU – Reduction of Hazardous Substances (RoHS)
- UN38.3 - UN Standard for Lithium battery shipping

Further details regarding declarations and certifications are available upon request. Please contact support@detectortesters.com for more information.

WARNING

If the XTR2 is used in a manner not specified by the manufacturer, the protection provided by the unit may be impaired.

Thank you for selecting Detectortesters for your equipment needs.

Your XTR2 has been designed with functionality, reliability, and safety in mind. It is your responsibility to use this instrument in conformance with local electrical codes. It is very important that the user follows installation instructions exactly as written. Do not attempt operation without this information.

1.5 Privacy Policy

XTR2 and DT Connect are covered by the Detectortesters (No Climb Products) privacy policy. Full details of the policy can be found on the Detectortesters website.

<https://www.detectortesters.com/privacy-policy/>

2

XTR2 INTRODUCTION

Thank you for purchasing the XTR2 multifunction Smoke-Heat Detector Tester.

This manual is designed to assist you to get the best and most efficient use of the XTR2 and provides all the information required to perform routine service and maintenance tasks with ease.

XTR2 includes advanced technology that simplifies functional testing of smoke, heat and multi-function detectors in the field.

Full functionality of XTR2 requires the use of the DT Connect app and Cloud Portal. Prior to first use, XTR2 must be registered and paired to the app in order to function.

Design Features

1. Tester cup
2. Cup membrane
3. Standoff plate
4. Smoke outlet
5. Heater element
6. Proximity sensor
7. Optical LED reader
8. LED torch
9. Air inlet
10. Power button
11. LCD touch display
12. Status LED's
13. Locking button
14. Battery pack
15. Smoke cartridge
16. Smoke generator
17. USB-C data port*

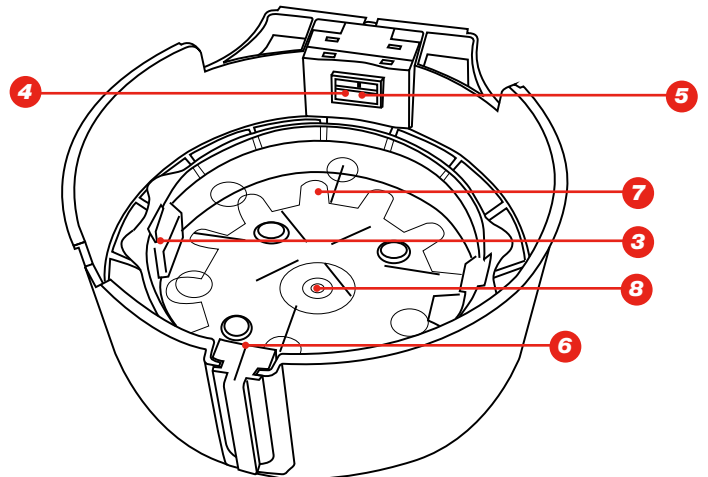
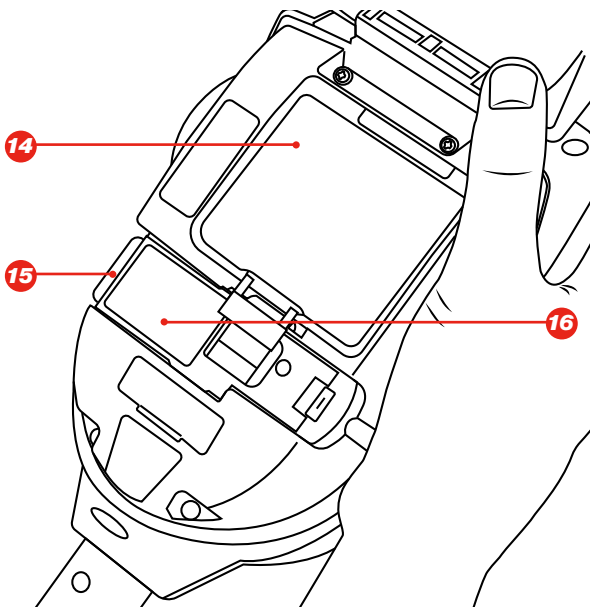
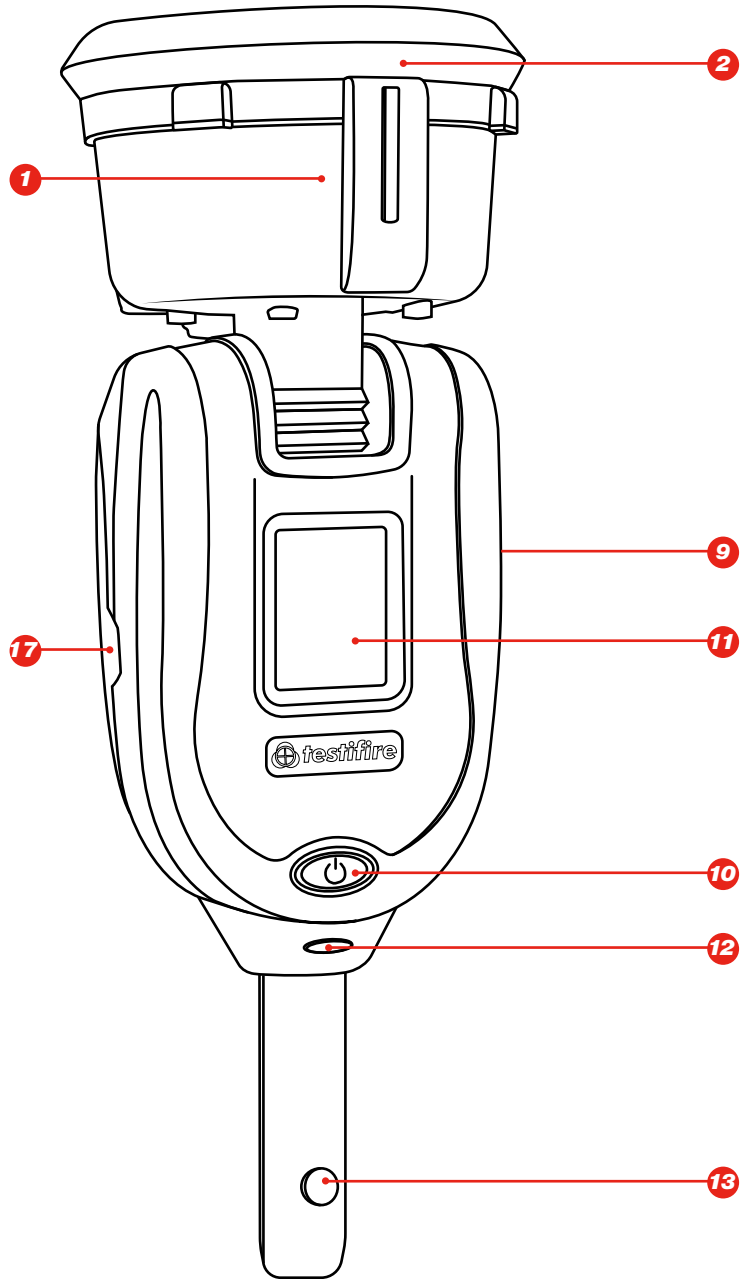

*only for firmware updates, not for charging of the battery.

3 PREPARATION FOR FIRST USE

3.1 Getting started with DT Connect:

STEP 1

Visit <https://detectortesters-connect.com> to create your account.

STEP 2

Sign into the Cloud Portal to register your device. Your XTR2 comes with an extended free trial of the connected services, which starts from the moment you register your device. You will be informed via the portal and DT Connect app when your free trial is about to expire, at which point you can choose to continue with a subscription to access all features.

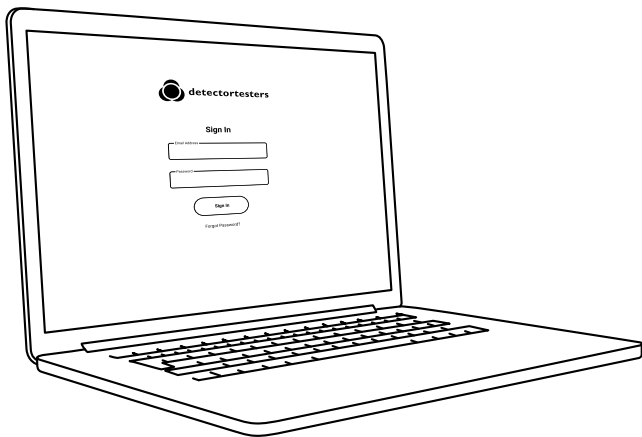

STEP 3

Download the DT Connect app for your smartphone device from the App Store or Google Play Store.

Get the DT Connect app



For help with DT Connect, including the app, Cloud Portal and subscriptions, scan the QR code:



Prior to first use:

The battery is charged by fitting the battery pack into the charge cradle and connecting to a mains socket using the supplied power adaptor (Fig. 1)

3.2 Charging the Battery

- Ensure the battery is fully charged before use.
- Do not charge the battery outside of the specified operating temperature range (5-45°C).
- At low ambient temperatures (5-10°C), the battery may not charge completely but may continue to indicate that charging is in progress.
- If the battery pack detects that the temperature is outside of the operational temperature range for charging, a fault will be indicated by a red flashing LED.
- In the event of a battery charging fault, remove the battery from the charging cradle, ensure the battery is within the operational temperature range and retry charging the battery.

Figure 1

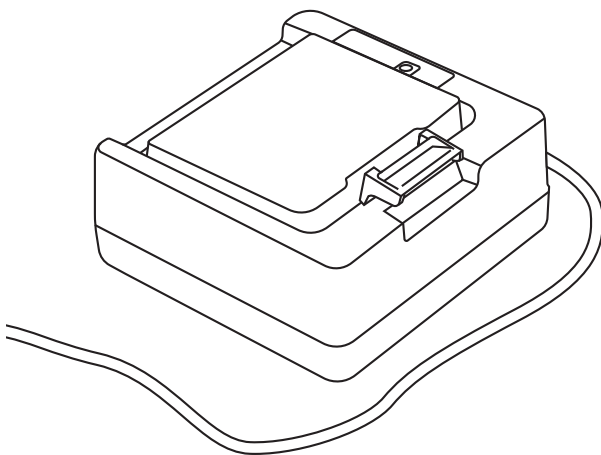

WARNING

Read cautions on lithium Ion rechargeable batteries before use (see page 2)

3.3 Installing the Generator

- Open the back cover
- Remove protective packaging of generator. Do not touch exposed electrical contacts.
- Insert generator firmly into recess, engaging clips 1 and 2 (see Fig.2)
- Once the generator is inserted, do not remove it until indicated that a replacement is necessary.
- When replacing a generator, any dust or debris within the XTR2 housing can be removed using an air duster. Any condensation can be removed by wiping with a lint-free cloth.
- Empty generators may be returned to the manufacturer via the reseller for environmentally friendly disposal to comply with WEEE (Waste Electrical & Electronic Equipment) Regulations.

Figure 2

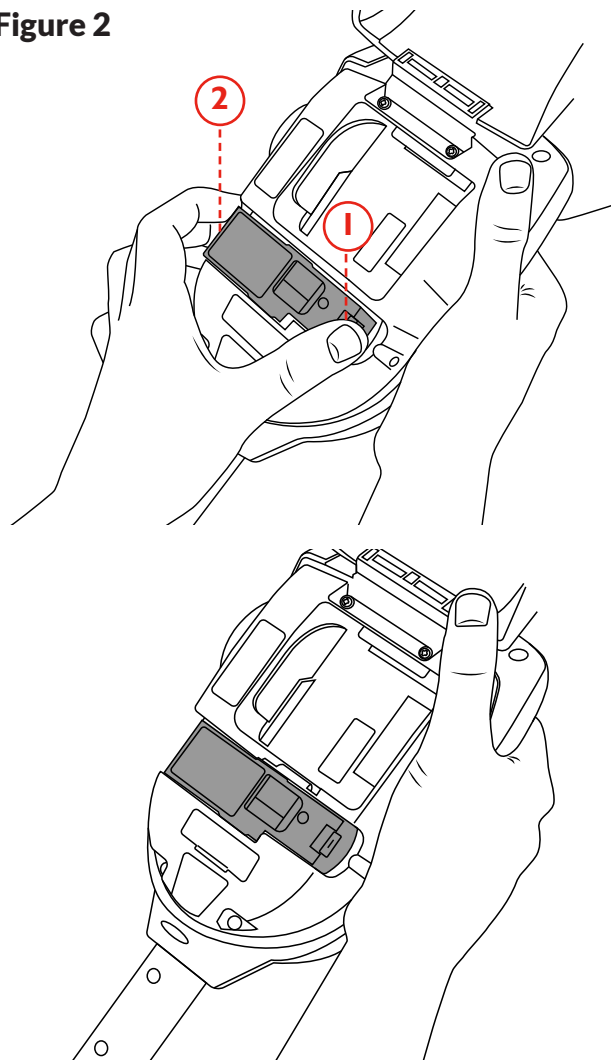

3.4 Inserting the smoke cartridge

- Remove the cartridge from bag.
- Do not insert the cartridge until the generator has been fully fitted to the main unit. See installing the Generator section 3.2.
- Slide cartridge completely into the generator housing following the guide rails (see Fig. 3)
- Once the cartridge is inserted do not remove it until indicated that a replacement is necessary. Do not re-use old cartridges.
- Empty cartridges may be returned to the manufacturer via the reseller for environmentally friendly disposal to comply with WEEE (Waste Electrical & Electronic Equipment) Regulations.

NOTE:
Do not insert the smoke cartridge until the generator has been fully fitted. In order to ensure maximum capacity from each new smoke cartridge, XTR2 must be paired with the DT Connect app.

 **WARNING**
Do not touch the contacts on the PCB on the cartridge. Static electricity may cause damage and contamination of the contacts must be avoided.

Figure 3



3.5 Inserting the Battery

- Once the battery is charged clip the battery pack into the battery compartment (Fig. 4).
- Do not force the battery into place
- Do not install the battery before the Smoke Generator and Smoke Cartridge
- Close the back cover before powering on

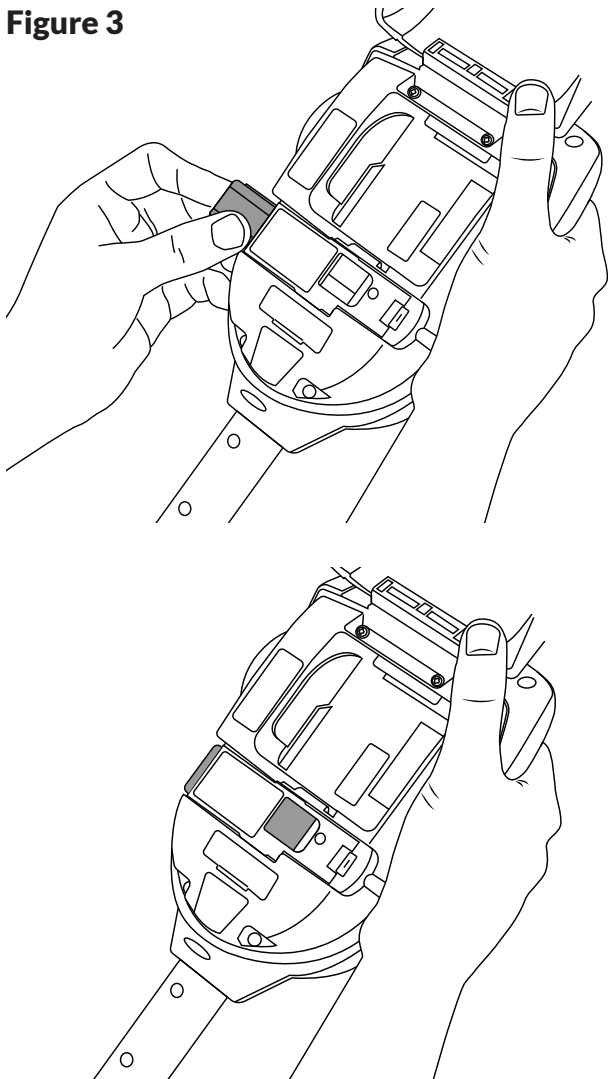
 **WARNING**
Do not touch the contacts on the battery. Static electricity may cause damage and contamination of the contacts must be avoided.

Figure 4



4

USING XTR2

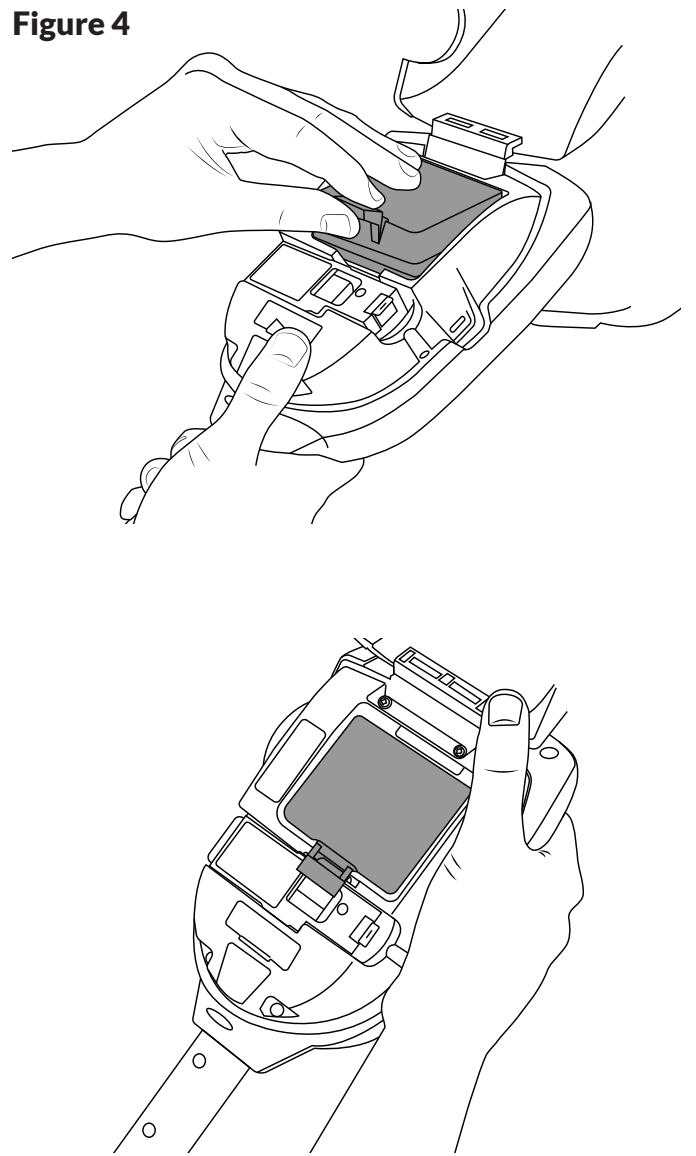
4.1 Attaching XTR2 to Solo Access Poles

XTR2 is designed for use with the Solo range of access poles (purchased separately). The product is not compatible with alternative poles.

Take the Solo access pole and press down the locking button on XTR2. Align it with the location hole and push the XTR2 handle further into the pole until the button springs up through the hole. Twist to lock (Fig. 5)

Figure 5

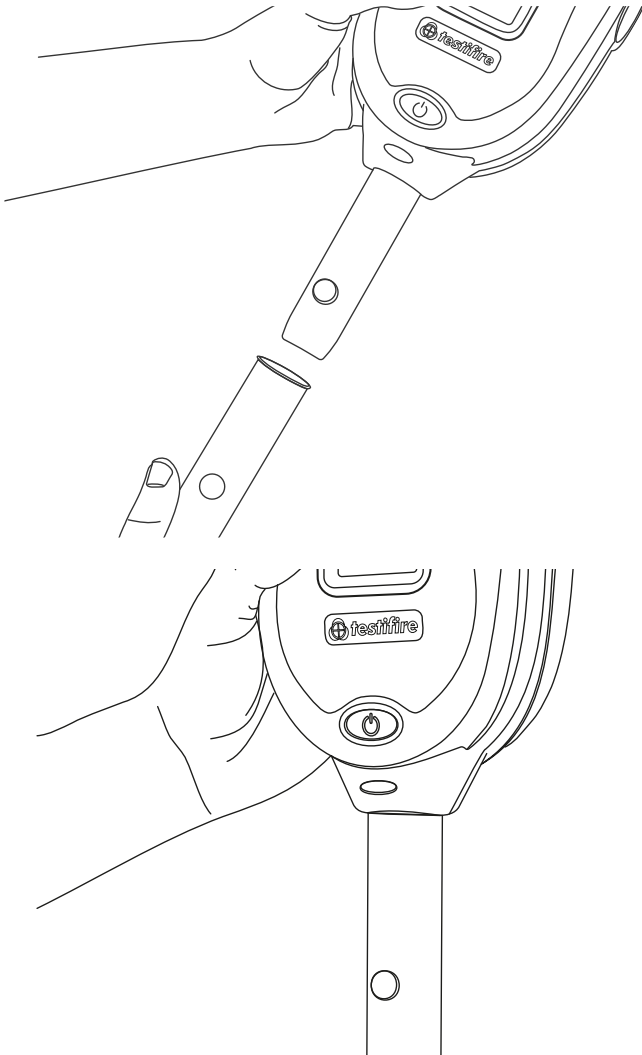

CAUTION

No more than three Solo extension poles should be used at the same time.

WARNING

When working at height it is recommended that a competent person carries out a suitable risk assessment. This will identify any risk to the user and/or the environment and hence any need for Personal Protective Equipment.

NOTE:

A Solo 101 extension pole can extend the Solo 100 and 108 telescopic poles, or may be used separately.

Similarly, a Solo 111 extension pole can extend the Solo 110.

For further information on the correct use of poles, see “instructions for Solo Poles” document in the support section of [detectortesters.com](https://www.detectortesters.com)

<https://www.detectortesters.com/manuals/>

4.2 Powering on XTR2

With the generator, cartridge and battery securely fitted and the back cover closed, the unit can now be powered on. Power the unit on by holding down the power button for 3 seconds.

NOTE:

After replacing a generator and powering on, a ‘purge cycle’ will run. During this the sound of the pump operating may be heard. This will last for approximately a few seconds after which, the unit will be ready for use. If no smoke is observed during a test a manual purge may be required (see section 5.8 for more detail on how to perform a manual purge).

The unit is functioning correctly if the status indicator LED’s are solid blue and a Smoke test is selected on the LCD display (Fig. 6). If the status indicator LED’s are not solid blue refer to the LED Reference Chart in section 4.3.



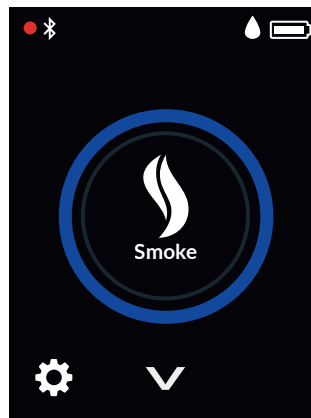







Figure 6



NOTE:

If XTR2 has been left unused for a period of time then a manual purge may be required.

4.3 LED Indicator Reference Chart

STATUS INDICATOR LEDS	
XTR2 indicates events as follows:	
WHEN IDLE	WHEN ACTIVE
 SOLID BLUE SMOKE TEST	 FLASHING BLUE SMOKE TEST ACTIVE
 SOLID RED HEAT TEST	 FLASHING RED HEAT TEST ACTIVE
 ALTERNATE SOLID RED/BLUE COMBINED TEST	 FLASHING ALT RED/BLUE COMBINED TEST ACTIVE
 SOLID ORANGE DELAYED START	 FLASHING ORANGE DELAYED START ACTIVE
 SOLID WHITE CLEARING	 FLASHING WHITE CLEARING ACTIVE
 SOLID PURPLE SYSTEM FAULT	 TRIPLE FLASHING GREEN PASSED TEST RESULT
	 TRIPLE FLASHING RED FAILED TEST RESULT

4.4 Adjusting the Head Unit Angle

Correct head angle adjustment is important to make sure that the detector to be tested is correctly positioned within the tester cup and that the user is in a safe and appropriate position to carry out the test.

The detector should touch the base of the XTR2 clear standoff and should be level with the base of the detector (Fig. 7)

Adjust the head unit for the correct angle to access the detector. Hold the body of XTR2 and gently move the cup forwards or backwards to the desired position.

Figure 7

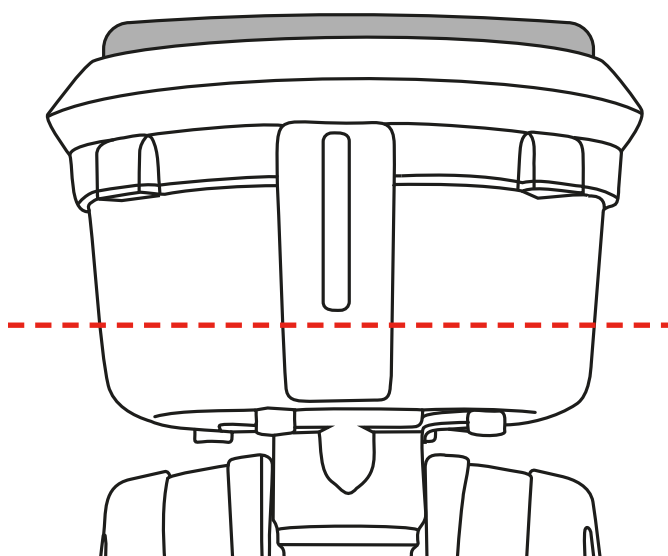

5

PERFORMING A TEST

5.1 Default Smoke Test

After you have completed the preparation procedures your XTR2 will be ready for use.

When powered on, XTR2 LCD will be configured to perform a smoke test by default. The smoke icon will be visible on the LCD display and the status LED's will be solid blue (Fig. 8).

Figure 8

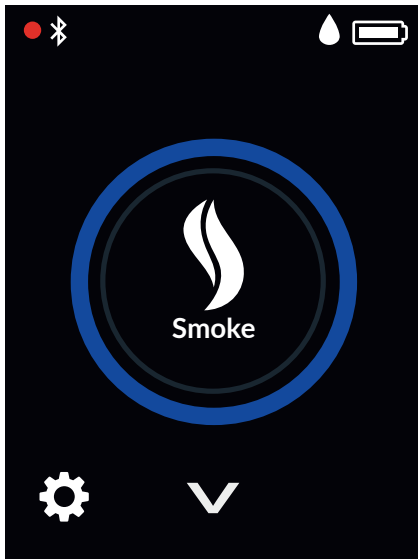

An infrared beam across the tester cup controls the test.

The test will begin automatically when the tester cup is placed over the detector, breaking the infrared beam.

The status LED will flash blue to indicate smoke is being generated and the test started (Fig. 9).

Figure 9

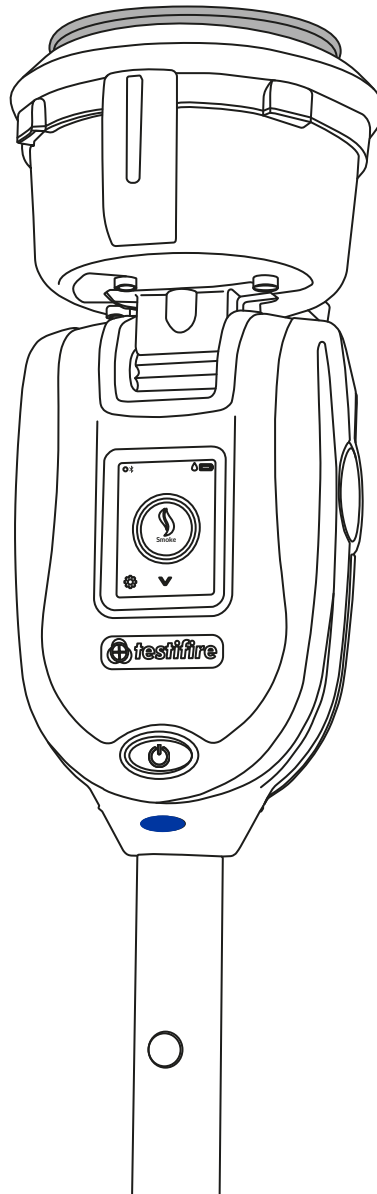

When the detector is activated, the optical LED reader inside the tester cup will sense the detector activation LED and automatically end the test.

The status LED's will flash triple green to indicate the test has been successful and clearing mode will begin automatically (see section 5.5). To end clearing, remove XTR2 by gently lowering it (Fig. 10).

Figure 10

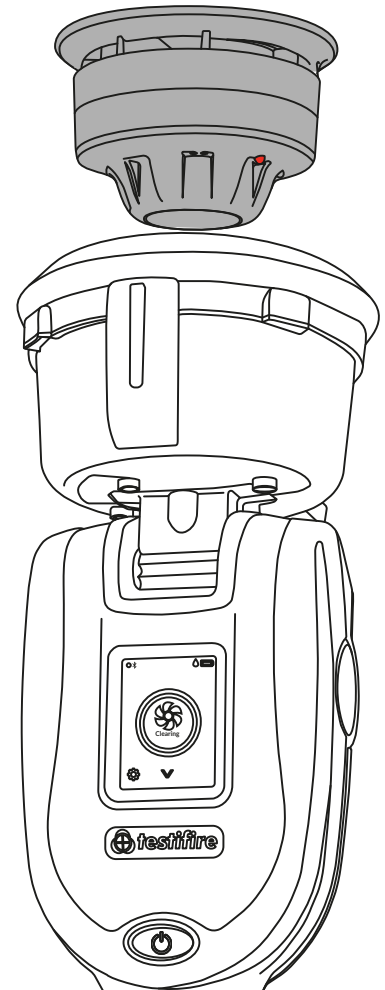

NOTE:

If after two minutes the test has not completed, XTR2 will time-out and the test will be recorded as failed. The status LED will flash triple red to indicate the test has been unsuccessful and you should remove XTR2 by gently lowering it.

5.2 Heat Test

Select the heat function using the navigation arrows on the LCD display. Once selected, the heat icon will be shown and the status LED will turn solid red.

Once the heat function is selected, tap the icon to select the high heat function. This will allow testing of high heat features. (Fig. 11)

Figure 11

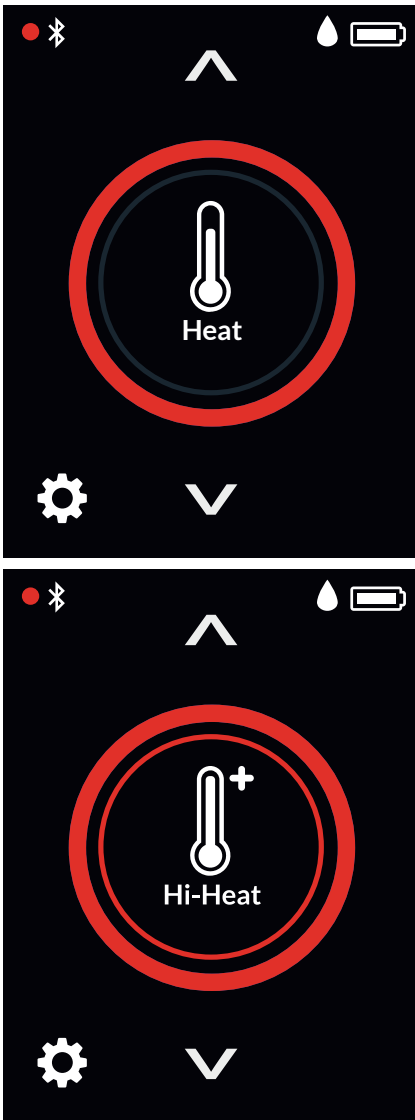

CAUTION

Avoid placing hands near the duct outlet during heat testing or within 5 minutes of conducting heat testing. Hot air is emitted from the duct and the top of the duct will get hot to the touch.

An infrared beam across the tester cup controls the test.

The test will begin automatically when the tester cup is placed over the detector, breaking the infrared beam.

The status LED will flash red to indicate heat is being generated and the test started (Fig. 12).

TIP:

Rotating XTR2 around the detector can speed up a test on detectors with offset thermistors

Figure 12

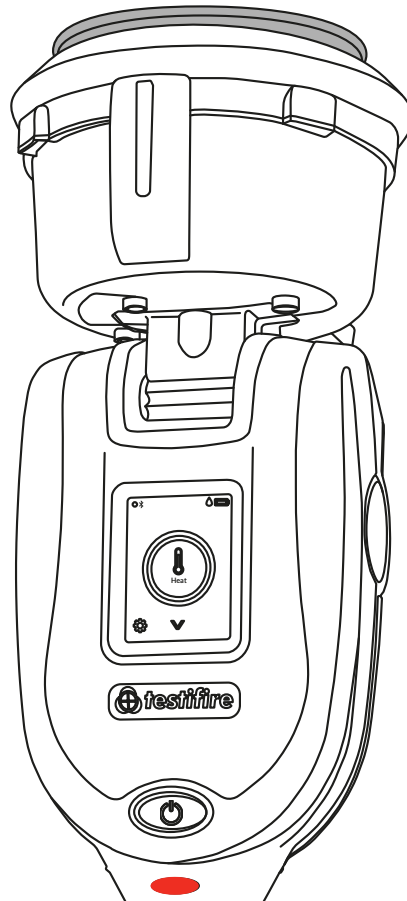

When the detector is activated, the optical LED reader inside the tester cup will sense the detector activation LED and automatically end the test.

The status LED will flash triple green to indicate the test has been successful and you should remove XTR2 by gently lowering it (Fig. 13).

Figure 13

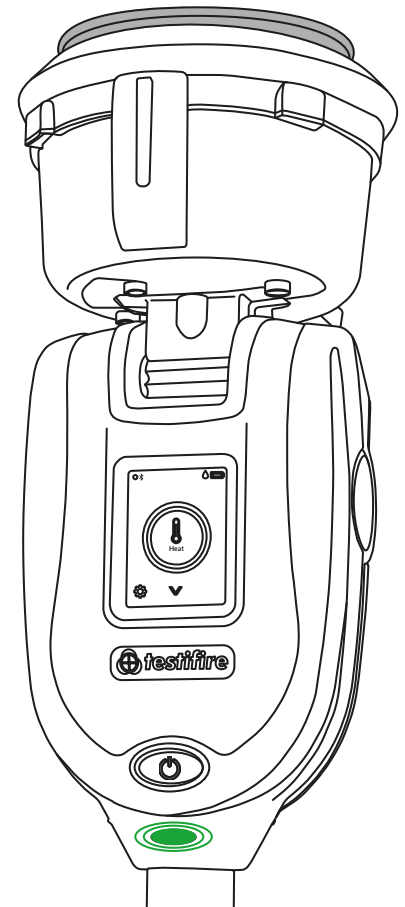

NOTE:

If after two minutes the test has not completed, XTR2 will time-out and the test will be recorded as failed. The status LED will flash triple red to indicate the test has been unsuccessful and you should remove XTR2 by gently lowering it.

5.3 Combined Test

Using XTR2 to carry out combined testing means that a number of operations (Smoke, Heat and Clearing) can be pre-programmed into the unit before it is raised up to the detector. This saves time, reduces handling and enables the testing of certain multi-sensor detectors.

Select the Combined function using the navigation arrows on the LCD display. Once selected the status LED's will alternate between solid blue and solid red (Fig. 14).

Figure 14

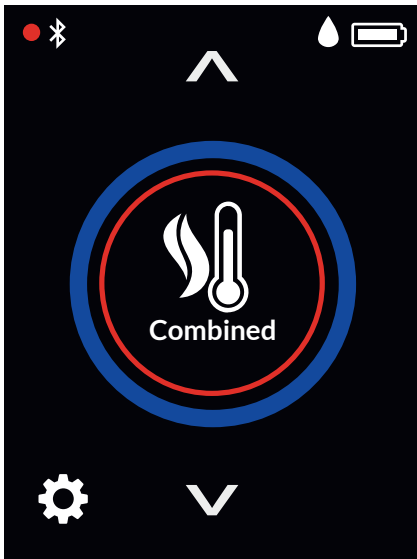

The test will begin automatically when the tester cup is placed over the detector, breaking the infrared beam.

When performing a combined test, the status LED will flash blue and red alternately to indicate both smoke and heat are being generated simultaneously (Fig. 15).

Figure 15

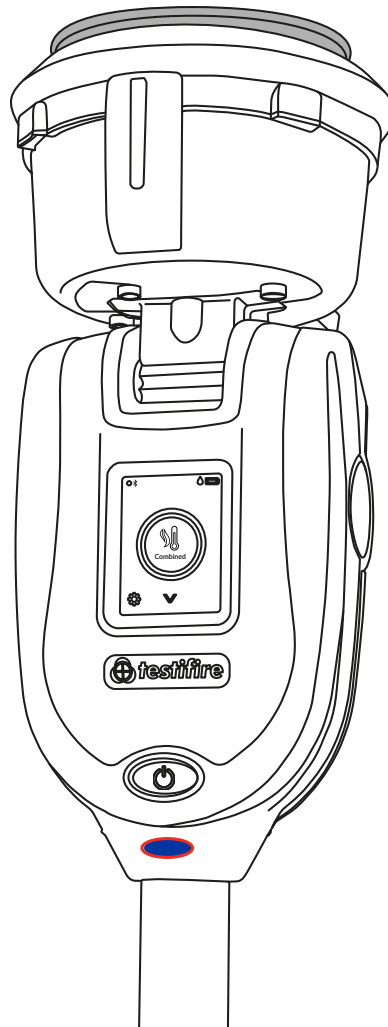

When the detector is activated, the optical LED reader inside the tester cup will sense the detector activation LED and automatically end the test.

The status LED's will flash triple green to indicate the test has been successful and clearing mode will begin automatically (see section 5.5). To end clearing, remove Testfire XTR2 by gently lowering it (Fig. 16).

Figure 16

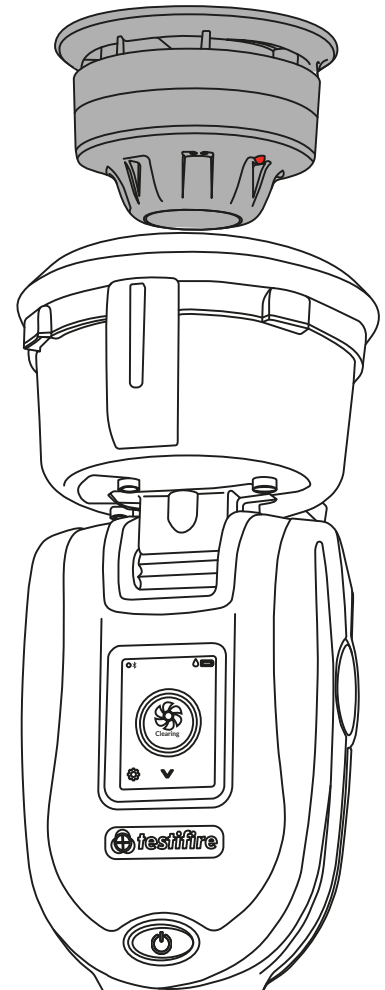

NOTE:

If after two minutes the test has not completed, XTR2 will time-out and the test will be recorded as failed. The status LED will flash triple red to indicate the test has been unsuccessful and you should remove XTR2 by gently lowering it.

5.4 Sequential Test

Using XTR2 to carry out a sequential test means that a number of operations (Smoke, Heat and Clearing) can be pre-programmed into the unit before it is raised up to the detector. This saves time, reduces handling and enables the testing of certain multi-sensor detectors.

Select the Sequential function using the navigation arrows on the LCD display (Fig. 17). Once selected the status LED's will turn solid red to identify the first test in the sequence as heat. Sequential tests follow the following predefined order:

1. Heat
2. Smoke
3. Clearing

Figure 17

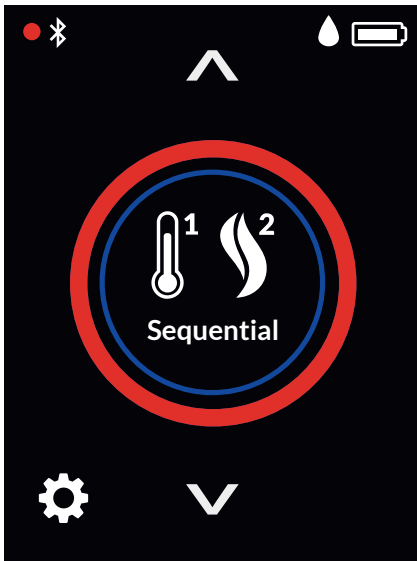

The test will begin automatically when the tester cup is placed over the detector, breaking the infrared beam.

When the detector is activated, the optical LED reader inside the tester cup will sense the detector activation LED. The detector LED must reset before the next test mode automatically begins (Fig. 18).

Figure 18

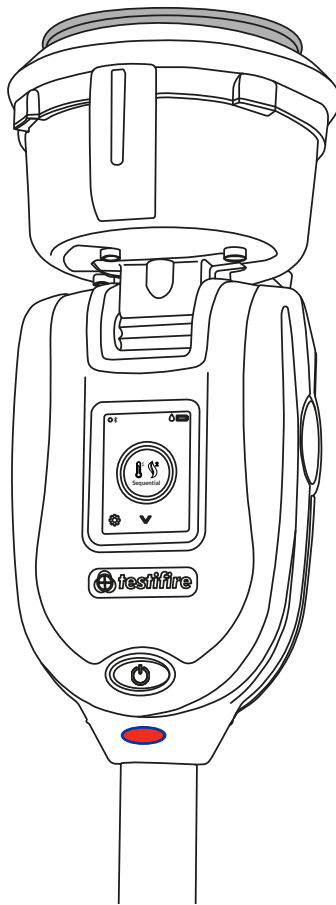

NOTE:
Lowering XTR2 from the detector during a sequential test will terminate the test.

Once the Sequential test is complete, the status LED's will flash triple green to indicate the test has been successful and clearing mode will begin automatically (see section 5.5).

To end clearing, remove XTR2 by gently lowering it (Fig. 19)

Figure 19

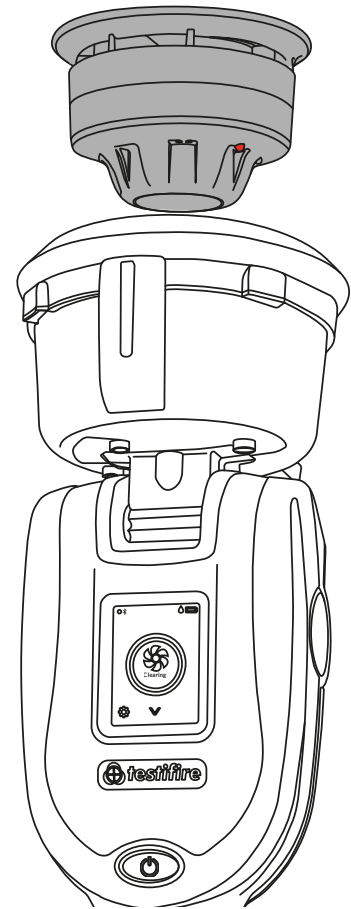

NOTE:
If after two minutes the test has not completed, XTR2 will time-out and the test will be recorded as failed. The status LED will flash triple red to indicate the test has been unsuccessful and you should remove XTR2 by gently lowering it.

5.5 Clearing a Detector

Once activated any lingering smoke can be cleared from the detector using the 'Clearing mode'. Air is blown around the detector – clearing any lingering smoke via the vent in the cup.

To perform clearing after a smoke, combined or sequential test, continue to hold XTR2 over the detector. If the test was successful, clearing will begin automatically and the status LED's will flash white (Fig. 20).

You can also use the navigation arrows on the LCD menu until clearing is displayed and raise XTR2 to a detector for clearing to begin.

Figure 20

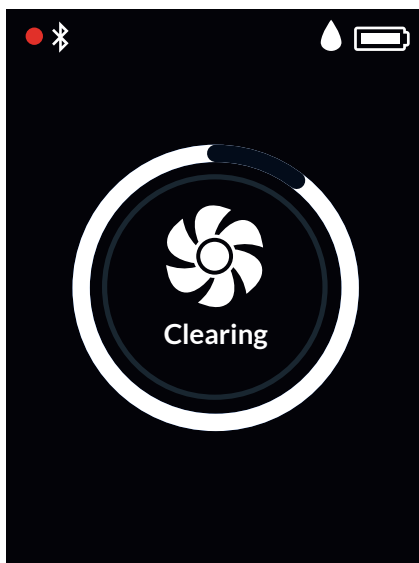

NOTE:

Automatic clearing does not occur following an unsuccessful test.

To perform clearing on its own, download the DT Connect app start a new Test Job:

1. Open the DT Connect app on your mobile device
2. Pair your XTR2 device and start a new test job
3. Select your test location and tap "next step"
4. Select the "Smoke" test mode and tap "Start Test".
5. Tap the "Clearing" icon in the top right hand corner

NOTE:

See section 8 for more information on using XTR2 with the DT Connect app.

5.6 Delayed Start

On occasions, it may be necessary to test detectors that do not easily fit into the XTR2 tester cup or are obstructed in some way. To allow testing of such detectors or aspirating smoke detection systems, XTR2 has the facility to delay the start of a test.

A separate adaptor (TESTIFIRE-ADAP-001) is required for ASD testing. Also see 6.1

To use this function, use the navigation arrows on the LCD menu until Delayed Start is displayed and tap the icon to begin the timer (Fig. 21).

Figure 21

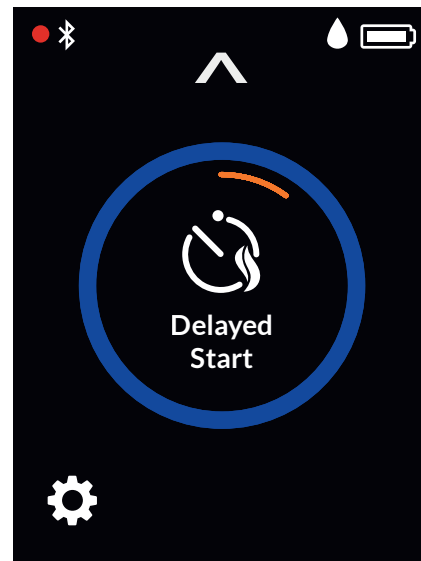

The default timer for the Delayed Start function is 20 seconds and can be adjusted using the DT Connect app.

1. Open the DT Connect app on your mobile device
2. Pair your XTR2 device and start a new test job
3. Select your test location and tap "next step"
4. Select the "ASD or Flat Detectors" test mode and tap "Start Test".
5. Choose from either 5, 20 or 40 seconds for the delayed start and tap "Start Test"

5.7 Using the LED Torch

In low light levels, an LED torch will automatically illuminate from inside the cup. This makes for easy alignment and testing of detectors in dark environments.

Upon alignment and the starting of the test the LED torch will switch off to allow a clear view of the status LED's and to enable the optical LED reader inside the tester cup.

5.8 Manual Purge

A manual purge may be required when the unit has not been used for a period of time, when in cold conditions, a new generator has been installed or in the case of a significant drop in performance. A manual purge should be carried out in a well ventilated.

Select the Settings icon from the bottom left corner of the LCD display and then select Purge. Tap the icon to begin the Purge function (Fig. 22).

Figure 22

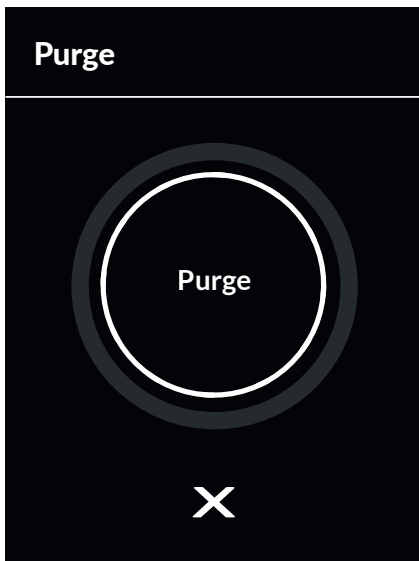

A manual purge can also be performed from the DT Connect app as follows:

1. Open the DT Connect app on your smartphone
2. Tap the Settings icon on the top left of the screen
3. Select "Help"
4. Tap "Purge"

NOTE:

See section 8 for more information on using XTR2 with the DT Connect app.

5.9 Device Settings

The device settings can be viewed by pressing the cog icon on your XTR2 display (Fig. 23). From this menu you can view the following settings:

1. Device information – including model, serial number, firmware version, battery serial number Bluetooth MAC address
2. Alarm detection mode – to choose if the optical LED reader responds to solid or flashing detector LED's, see section 9.5.2.1
3. Bluetooth settings – to access Bluetooth QR code for pairing with mobile devices
4. Purge – to perform a manual purge of the smoke generator (see section 5.8)

Figure 23

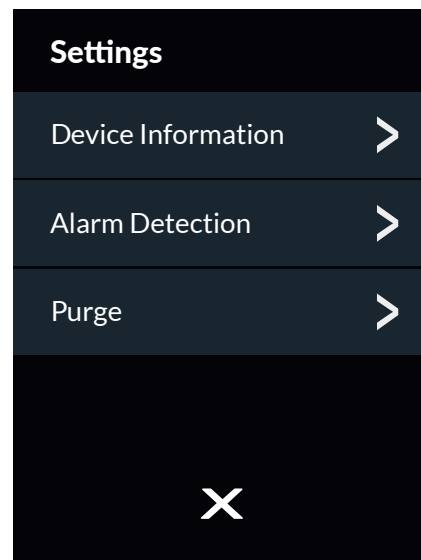

6 ASD ADAPTOR – TESTING ASD SYSTEMS AND FLAT DETECTORS

6.1 Testing an ASD System or Flat Detectors

ASD systems and Flat Detectors can be tested using the Delayed Start mode and changing the tester membrane to the ASD Adaptor (Product Code: TESTIFIRE-ADAP-001).

2. The application has been thoroughly tested independently with all ASD technologies and a wide range of Flat Detectors.

6.2 Installing the ASD Adaptor

1. Ensure XTR2 is powered off
2. Remove the XTR2 membrane (see section 7.7)
3. Attach the ASD adaptor, stretching it over the tester cup and ensuring the tongues align with the relevant grooves in the tester cup (Fig. 24).

Figure 24

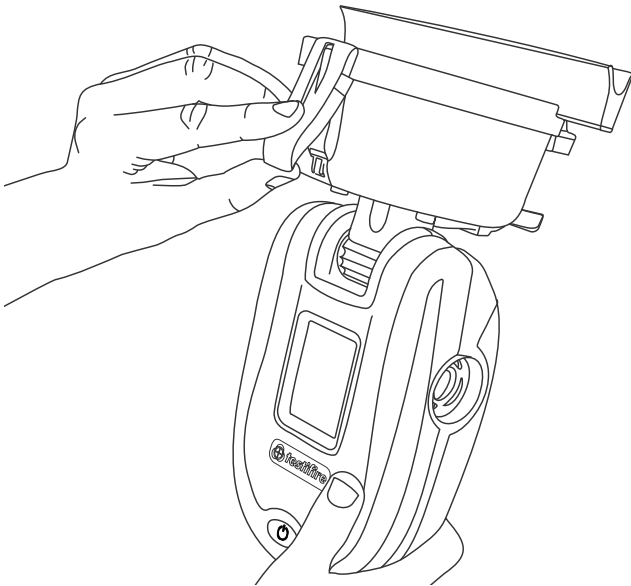

6.3 Testing with the ASD Adaptor

1. Power on XTR2
2. Select the Delayed Start mode by using the navigation arrows on the LCD display.
3. Tap the Delayed Start icon to begin the timer. During the timer the status LED's will flash orange
4. Locate XTR2 over the sampling hole. Smoke will automatically be generated for 20 seconds indicated by the status LED's flashing blue (Fig. 25).

Figure 25

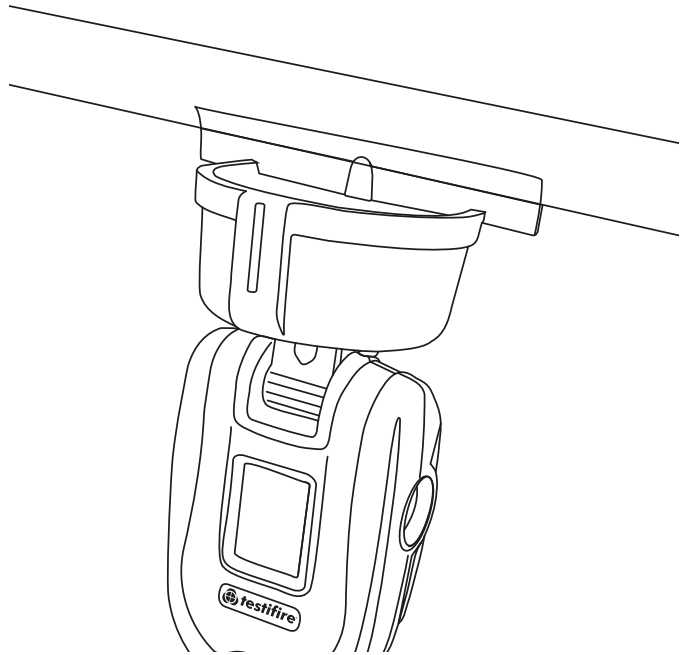

NOTE:

The delayed start timer is set to a 20 second by default and can be configured via the DT Connect App (see section 5.6).

7

REMOVING AND REPLACING CONSUMABLES

All consumable parts of XTR2 can be replaced in the field without having to return the unit for service.

Ensure that the unit is switched off during the replacement of consumables. Do not touch electrical contacts.

7.1 Removing the Smoke Cartridge

1. Ensure the unit is switched off and open the back cover
2. Remove the smoke cartridge from the generator by placing your thumb in the recess and sliding the cartridge along the guide rails (Fig. 26). Do not remove the Generator

Figure 26

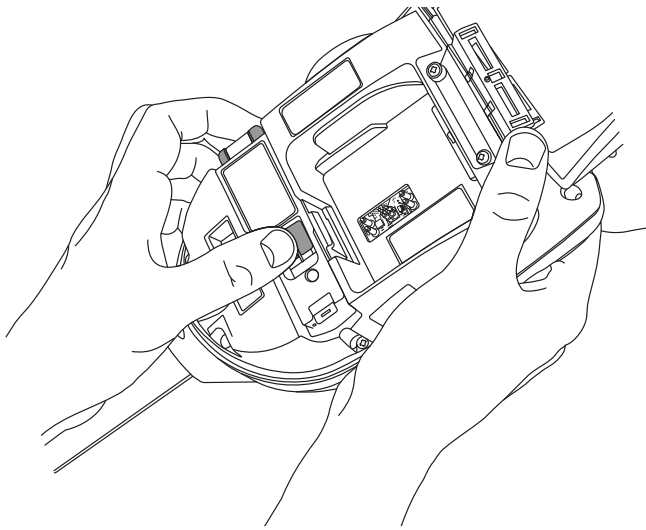

7.2 Replacing the Smoke Cartridge

1. Remove the Cartridge from the bag
2. Slide the cartridge completely into the generator housing following the guide rails (Fig. 27)
3. Once the cartridge is inserted into the generator do not remove it until indicated that a replacement is necessary on the LCD display or in the DT Connect app

Figure 27

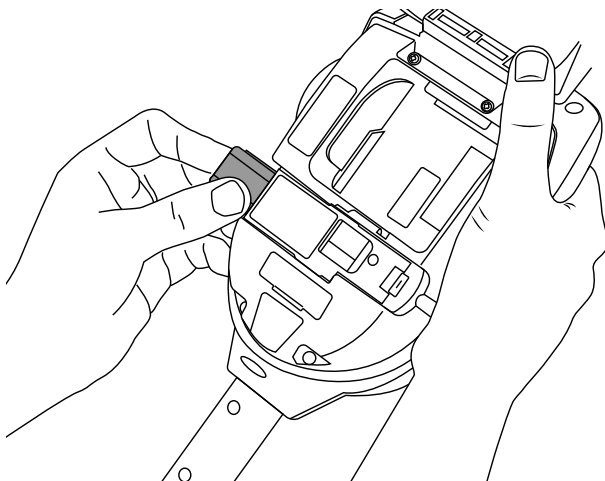

NOTE:

Do not re-use empty cartridges. Empty cartridges may be returned to the manufacturer via the reseller for environmentally friendly disposal to comply with WEEE (Waste Electrical & Electronic Equipment) Regulations.



WARNING

Do not touch the contacts on the cartridge. Static electricity may cause damage and contamination of the contacts must be avoided.

7.3 Removing the Smoke Generator

1. Ensure the unit is switched off and the Smoke Cartridge is removed (section 7.1)
2. Disengage Clip 1 and lift. Repeat for Clip 2 to remove the used generator (Fig. 28)

Figure 28

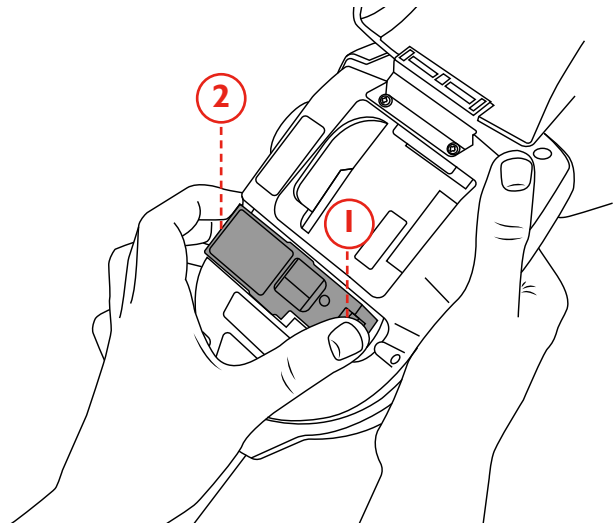

NOTE:

When replacing the generator, any dust or debris within the housing can be removed using an air duster. Condensation can be removed by wiping with a lint-free cloth.

7.4 Replacing the Smoke Generator

1. Insert the generator firmly into the recess, engaging clips 1 and 2 (Fig. 29)

Figure 29

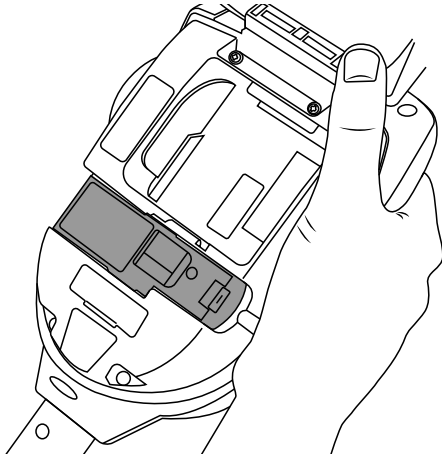

NOTE:

Once the generator is inserted do not remove it until indicated that a replacement is necessary on the LCD display or in the DT Connect app.



WARNING

Do not touch the contacts on the generator. Static electricity may cause damage and contamination of the contacts must be avoided.

7.5 Removing the Battery for Charging

1. Ensure the unit is switched off and open the back cover.
2. Unclip and remove the battery
3. Insert the battery into the charge cradle
4. Charge the battery by connecting the USB-C lead to the charge cradle and the supplied mains power adaptor or car adaptor (see Section 3.1)

CHARGE CRADLE STATUS LED COLOUR



FLASHING GREEN
BATTERY CHARGING



SOLID GREEN
BATTERY FULLY CHARGED



SOLID RED
NO BATTERY CONNECTED



FLASHING RED
BATTERY FAULT

7.6 Replacing the Battery

1. Once the battery is charged gently clip it into the battery compartment and close the back cover (Fig. 30)

Figure 30

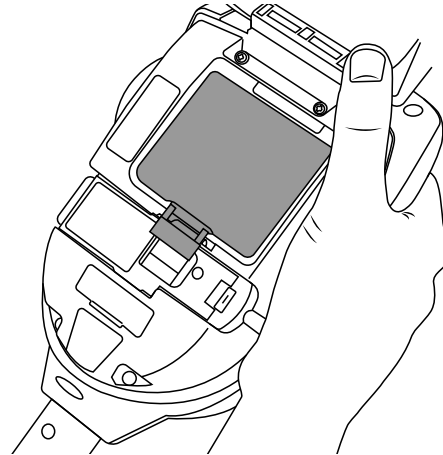

NOTE:

Do not force the battery into place.



WARNING

Do not touch the contacts on the battery or charge cradle. Static electricity may cause damage and contamination of the contacts must be avoided.

7.7 Removing and Replacing the Membrane

1. Ease the membrane off the tester cup carefully
2. Take the replacement membrane and stretch it over the tester cup. Ensure the membrane tongues align with the relevant grooves in the tester cup (fig. 31)

Figure 31

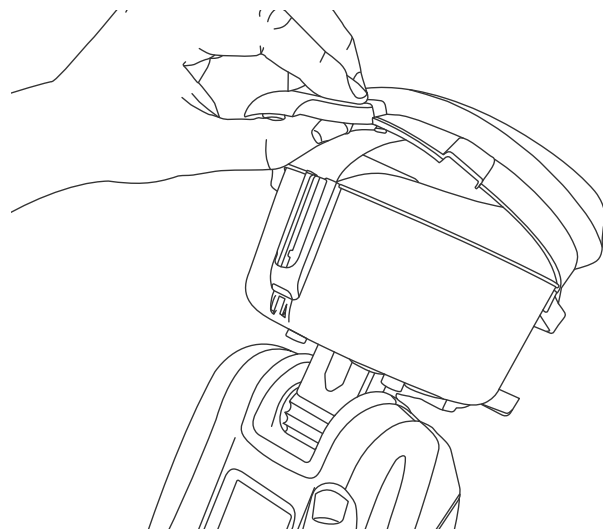

8

DT CONNECT APP: GETTING STARTED

The DT Connect app provides several features and benefits to help you make the most of your XTR2. These include access to advanced test modes and digital test reports, which provide proof of compliance.

8.1 Downloading the App

The DT Connect app can be downloaded from the App Store for iPhone and the Google Play Store for Android devices. The following smartphones are supported:

- Apple iPhone with iOS 17 or later
- Android OS 8 or later

8.2 Signing In

Once you have downloaded the DT Connect app, Tap “Get Started” to sign in (Fig. 32)

Figure 32

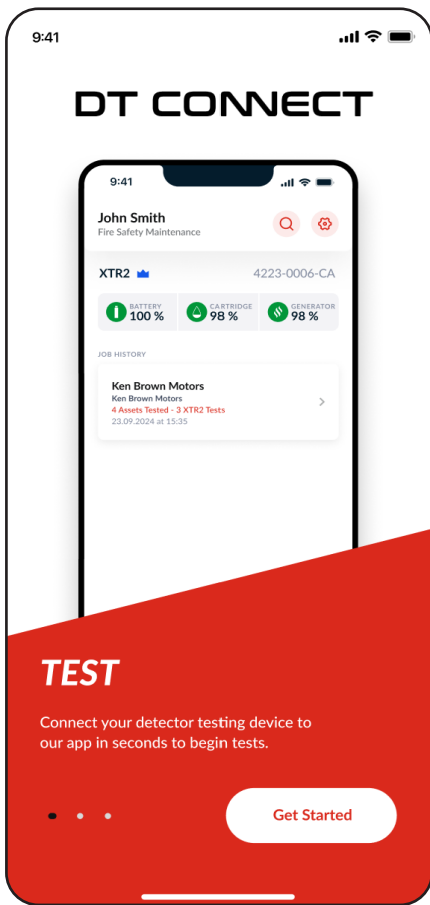

Enter the same email address used to register your account on the Cloud Portal and tap 'Next' (Fig. 33).

Figure 33

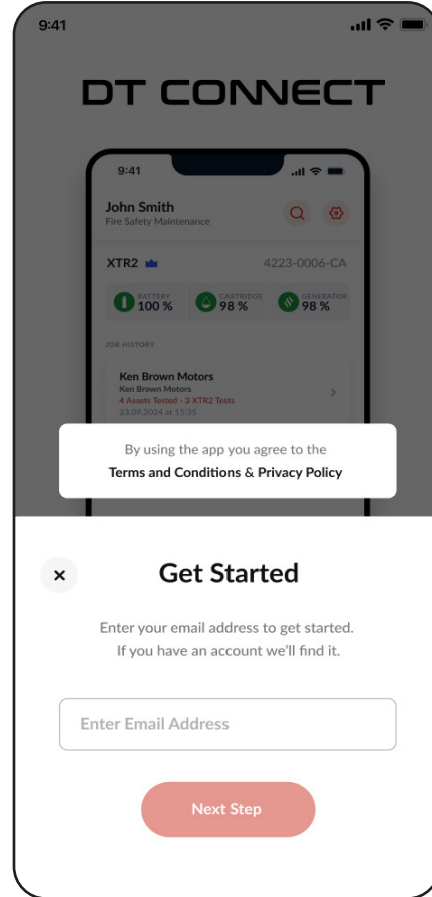

Enter your password and tap “Next” (Fig. 34)

Figure 34

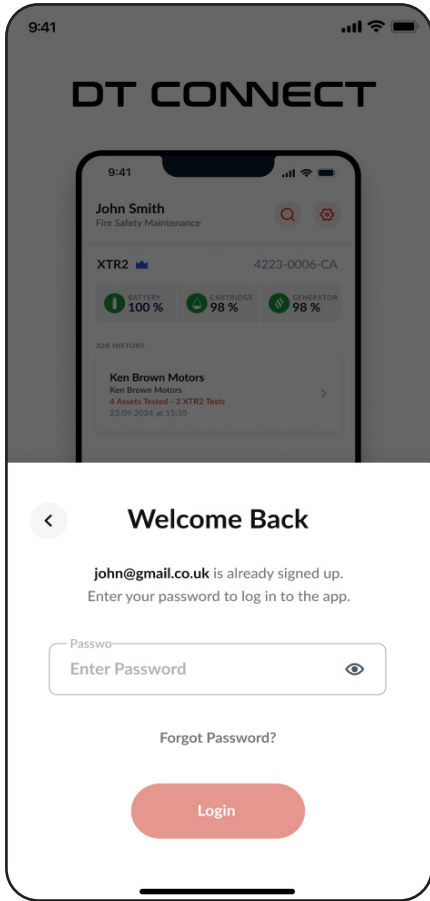

If your company is already registered with DT Connect and they have not pre-registered your account, you will be asked to create a new profile (Fig. 35)

Figure 35

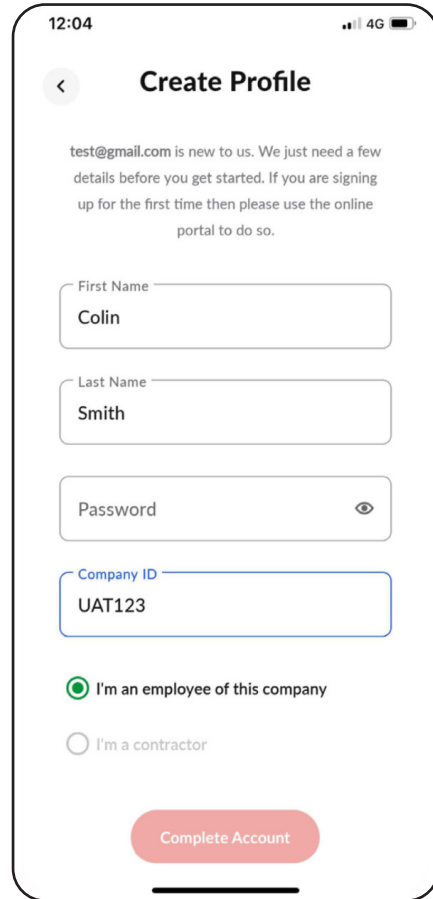

NOTE:
A Company ID is required to register a new profile with a company. If you do not have this, ask your administrator to send the code or invite your email address via the Cloud Portal.

The Company ID can be found in the Settings Menu on the Cloud Portal.
See section 8 of DT Connect User Guide

8.3 Pairing your XTR2

Once XTR2 is registered to your company, pair it with the DT Connect app (Fig. 36)

1. Tap 'Connect Device' on the home screen.
2. Select your XTR2 device from the device list and tap 'Confirm'.
3. Enter the Bluetooth passcode displayed on your XTR2 display.
4. Once your XTR2 is connected, it's serial number and consumables status are displayed on the app home screen.

Figure 36

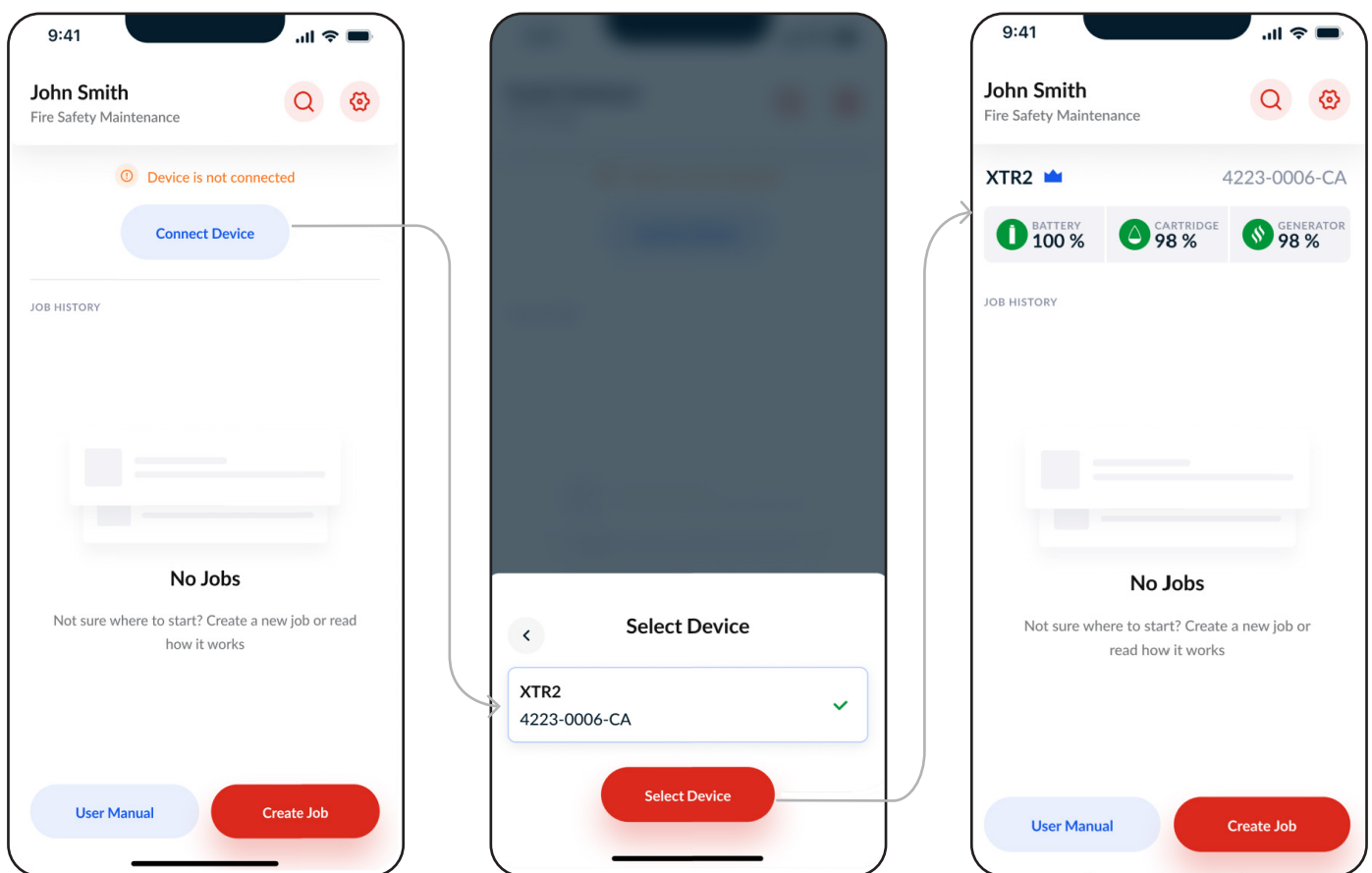

8.4.1 Device Membership

The XTR2 can be used immediately out of the box with a 90-day trial of Premium Membership upon registration in the Cloud Portal. Once the 90-day trial is over, the device will be automatically downgraded. To retain premium membership, subscribe your device through the Cloud Portal.

A full breakdown of the features can be seen in the Free vs. Premium Matrix (see Section 8.4.3).

Membership is unique to each device, so multiple devices must be subscribed individually. (See Section 3 of the DT Connect User Guide).

IMPORTANT :
The level of device membership directly corresponds to the features accessible within the job and following report

For example: If the job was created with a Free device, the user will NOT have the ability to create assets, or generate a PDF report to send to the client. The site will NOT be saved to re-test in the future. These are all Premium Device features.

Reports created with Premium Devices will always stay premium even if the device membership is cancelled.

8.4.2 Membership Visibility in the App

Devices without membership have access to the free version of the app. This can be distinguished by a grey crown icon on the Dashboard when the device is connected or by a grey banner in an active job. (Fig. 37)

Devices with Premium Membership have a blue crown icon on the Dashboard when connected and a blue banner in an active job. (Fig. 38)

Figure 37

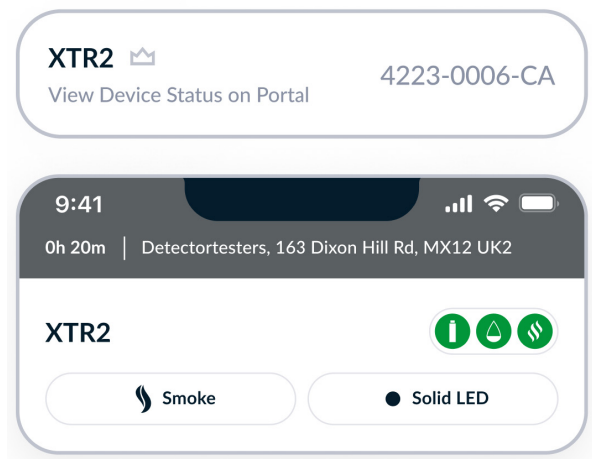
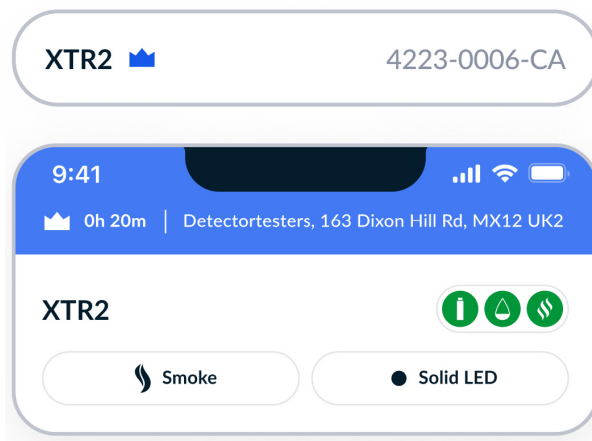

Figure 38



8.4.3 Free vs. Premium App Features

Below is a comparison matrix of app features between Free and Premium Device Memberships.

Free Device Membership offers the user the ability to capture test results with the XTR2 digitally to produce internal records of jobs completed

Premium Device Membership offers companies a full suite of features to allow engineers to fully capture the testing done on site, create a site asset list and share a proof of testing PDF report with the client. All records are saved to the Cloud Portal to enable repeat site testing to enhance service and maintained efficiency.

To upgrade your device to Premium Membership, log in to the Cloud Portal ([see Section 2.3 of the DT Connect User Guide](#)).

Feature	Description	Free	Premium
Test New Site	Job creation for a new site (section --)	✓	✓
XTR2 Test Result Capture	Capture test results from the XTR2 in the app (section --)	✓	✓
Hardware Configuration	Ability to configure XTR2 in the app [e.g Test Mode] (Section --)	✓	✓
Test Existing Site	Job creation for a site previously visited and saved (section --)	✗	✓
Site Asset List	Asset list stored and maintained in the Cloud Portal (section --)	✗	✓
Asset Creation	Ability to enter location details to create an asset (section --)	✗	✓
Floor Walk Filter	Filter assets by Type, Zone, & Loop (section --)	✗	✓
Panel Reconciliation	Check test results against Fire Panel event Log (section --)	✗	✓
Client Signature Capture	Capture a client signature for your report (section --)	✗	✓
PDF Report Generation	Generate a PDF report of job for proof of testing (section --)	✗	✓
CSV Asset Upload	Easily transfer asset lists using our CSV template (section --)	✗	✓
Share PDF Report	Share PDF with the client via email (section --)	✗	✓

NOTE:

Features in any in-progress jobs will remain unchanged if the device is subscribed or unsubscribed during the job.

Changes will take effect when a new job is created.

9

DT CONNECT APP: JOB CREATION

9.1.1 Test a New Site

Tap 'Create Job' to navigate to the Job Type screen and begin creating a new site (Fig. 39). The new site and any assets created will be saved to the Cloud Portal once the job is complete. Once saved a site can be re-tested using the 'Test Existing Site' flow.

1. Tap 'Test New Site'
2. Use the search bar to enter your site address and tap 'Continue' to proceed.
 - a. If an internet connection is unavailable, tap 'Enter Address' to manually enter the site address.
3. Enter 'Client Name' and tap 'Start Job'

Figure 39

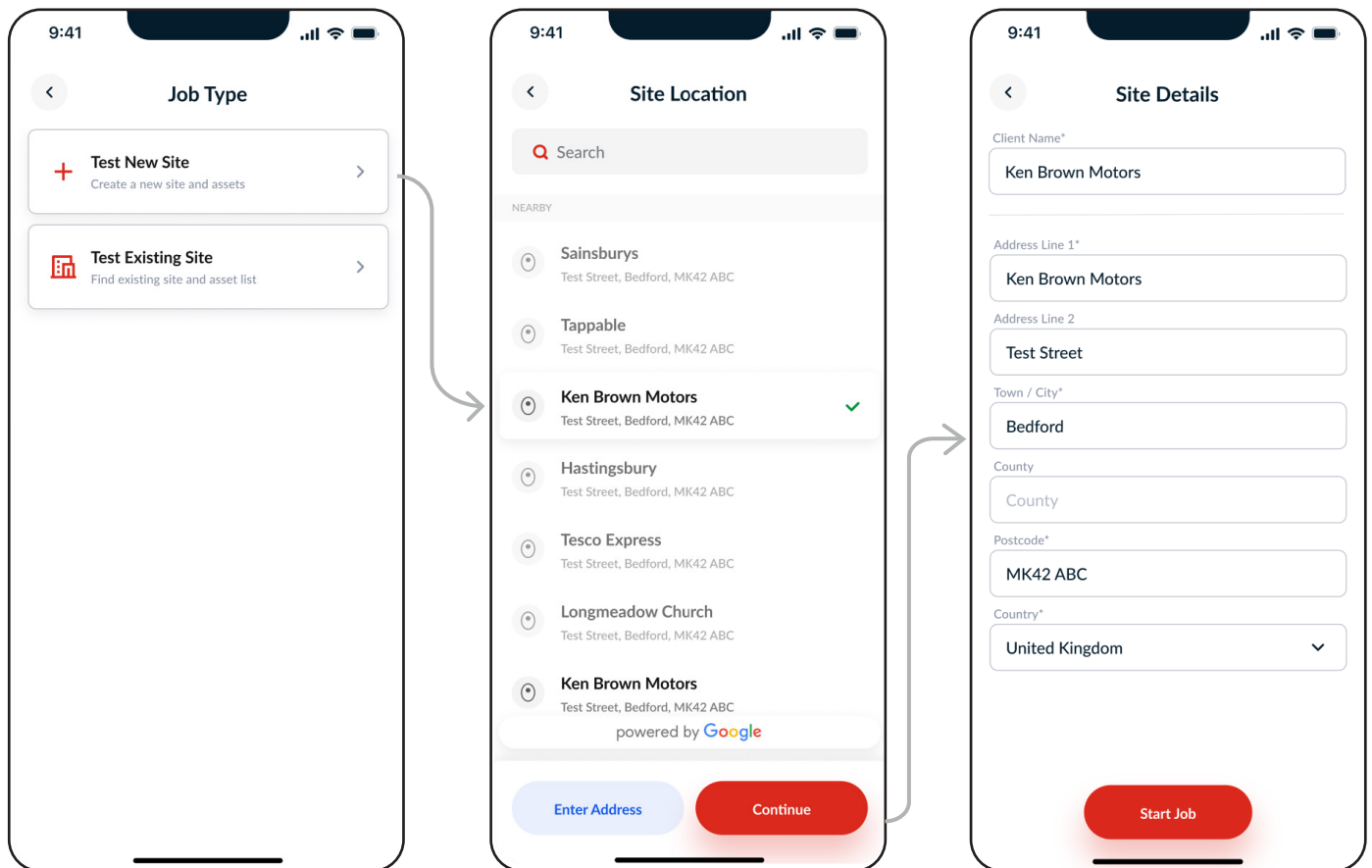

NOTE:

Devices with Free Membership can only test new sites. They will not have access to the Job Type screen when creating a job.

9.1.2 Creating the Fire Panel Asset (Premium)

Once the job has started, you will be prompted to set up the Fire Panel asset. This step is used to identify the panel in test, and correctly link any connected panel assets subsequently tested.

1. Depending on the panel type in test, select either the Addressable Panel or Conventional Panel.
2. Enter the Fire Panel Details: Location (required), Zone, and Test Notes.
3. Log the Fire Panel time (to synchronise the panel time with real-time).
4. Select a PASS, FAIL, or UNABLE TO TEST result.
5. Tap 'Create Asset'

Figure 40

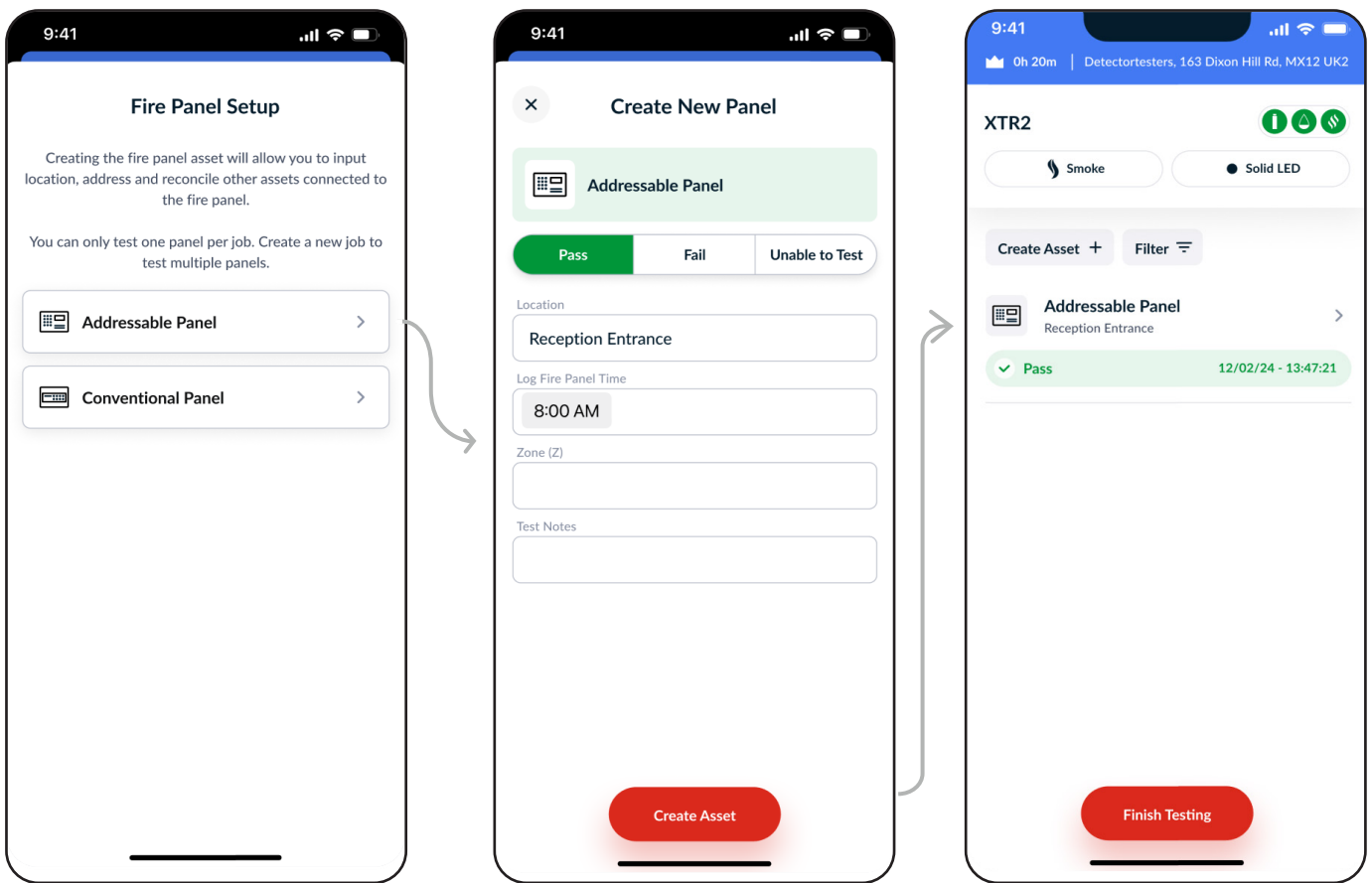

NOTE:

- ✓ Test ONE Fire Panel per job
- ✓ Test ANY Non-Panel assets, as they are not configured to a Fire Panel. (see Section --)
- ✓ Log the time for Addressable Panels to aid with test reconciliation. (see Section --)
- ✗ Test Connected Panel Assets if they are NOT configured to the Fire Panel being tested. (see Section --)

9.2.1 Test an Existing Site (Premium)

After a site has been tested once, you'll be able to create a job using the saved details from your initial visit to speed up testing. On the Site Page, you'll find a historical list of reports and assets associated with the site (Fig. 41).

1. Tap 'Test Existing Site'.
2. Use the search bar or select a site from the 'Recent' list.
3. Once on the Site Page, tap 'Create Job'

Figure 41

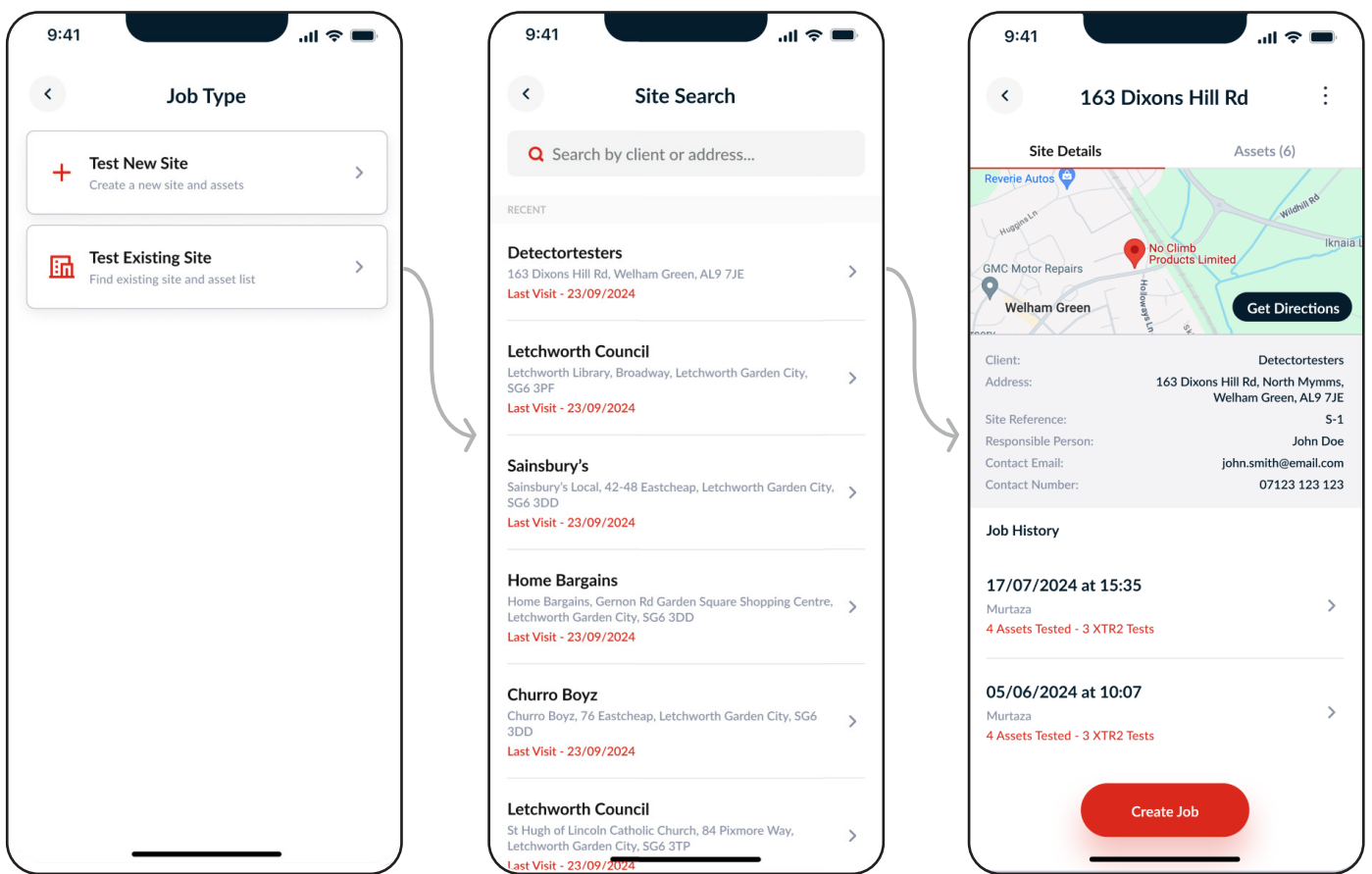

NOTE:

Testing an existing site requires an internet connection to retrieve the list of Sites and Assets from the Cloud Portal.

9.2.2 Site Asset List

Use the 'Assets' tab on the Site Page to take a closer look at the assets identified on-site. Tap on a panel asset to expand and view the connected assets. (Fig. 42)

Figure 42

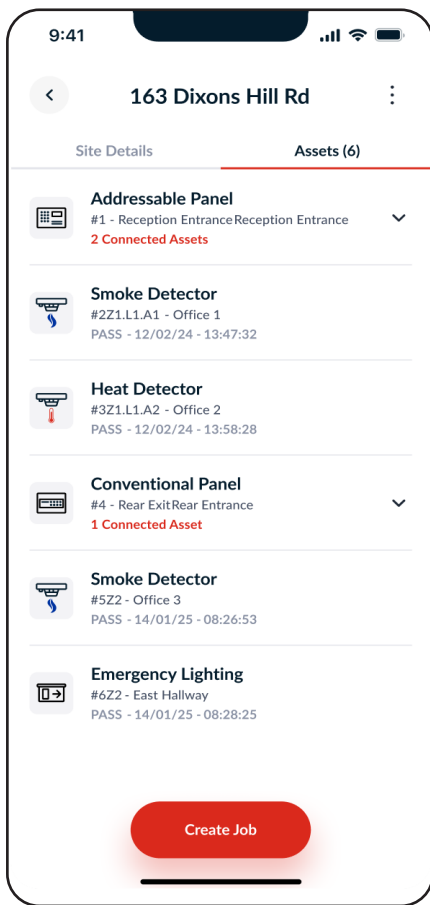

9.2.3 Asset Selection

When you tap 'Create Job' on the Site Page, you will be prompted to select assets to test. Use this screen to make the following selections: (Fig. 43)

- **Test New Fire Panel:** Create a new panel asset to test on your new visit.
- **Select an Existing Panel:** Import the selected panel and all connected assets for testing on your new visit.
- **Select Non-Panel Assets:** Import any non-panel assets for testing on your new visit.

Figure 43

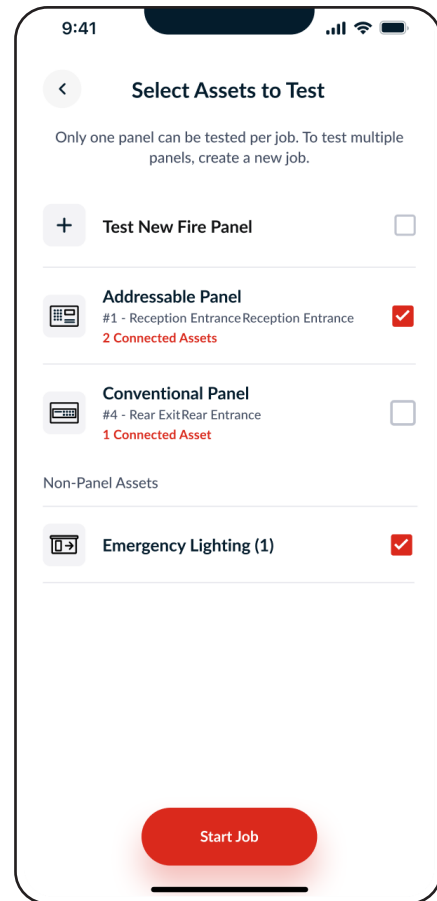

NOTE: Only one panel and its connected assets can be tested per job. To test a second panel, create a new job.

10 DT CONNECT APP: FLOOR WALK SCREEN

10.1.1 Floor Walk Screen - Premium Devices

Once job creation is complete, you will arrive at the Floor Walk screen, which serves as the main testing interface for the job. Here, you can control your device and complete tests. (Fig. 44)

At the top is the Device Control section. When connected to the XTR2, you can configure the Test Type and Alarm Detection modes using the app. You can also view the device Status Indicator Menu (Battery, Cartridge & Generator).

Below are the secondary action buttons: 'Create Asset' and 'Filter'. These allow you to manually create assets and filter the Event Log, where all tests and assets are recorded in a list format.

FEATURES:

1. Status Indicator Menu
2. Test Type
3. Alarm Detection
4. Create Asset
5. Filter
6. Test Log

Figure 44

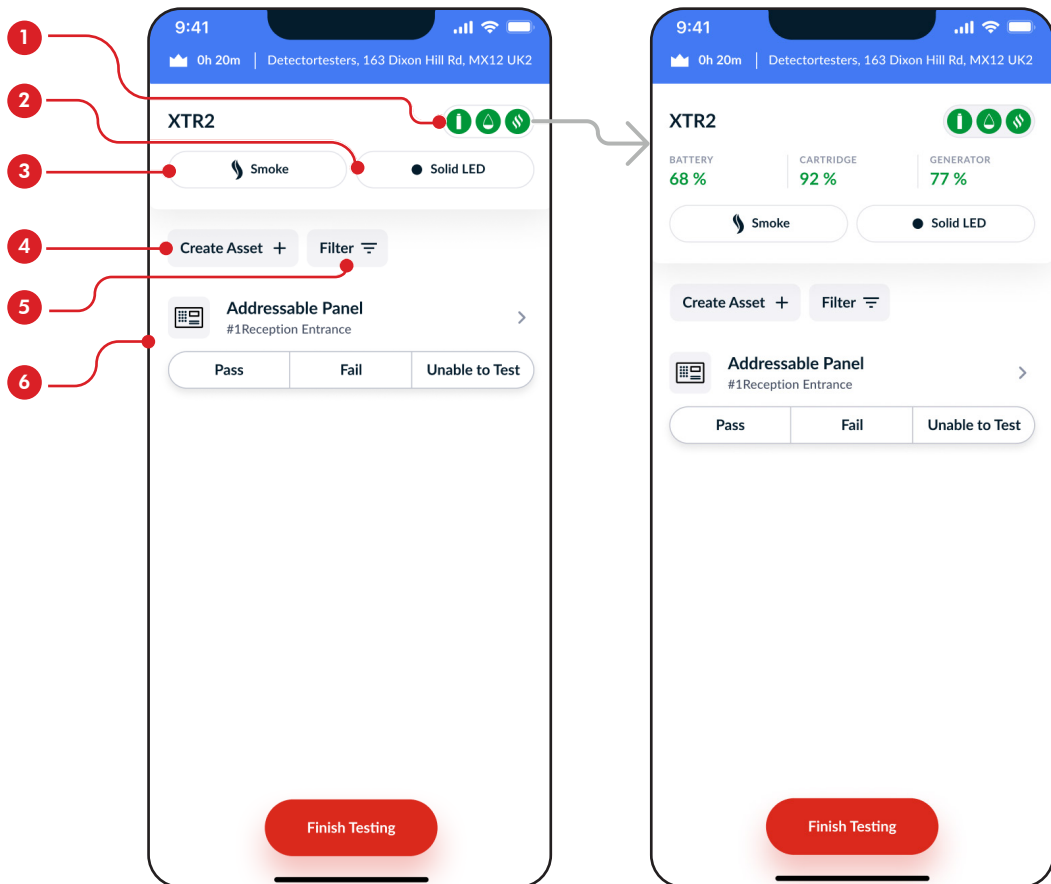

10.2.1 Changing Test Mode

To change the test mode, tap the 'Test Type' button and select a mode from the list (Fig. 45). When a new mode is selected, the status LEDs on the XTR2 will change to indicate the new selection. (see section 4.3).

Figure 45

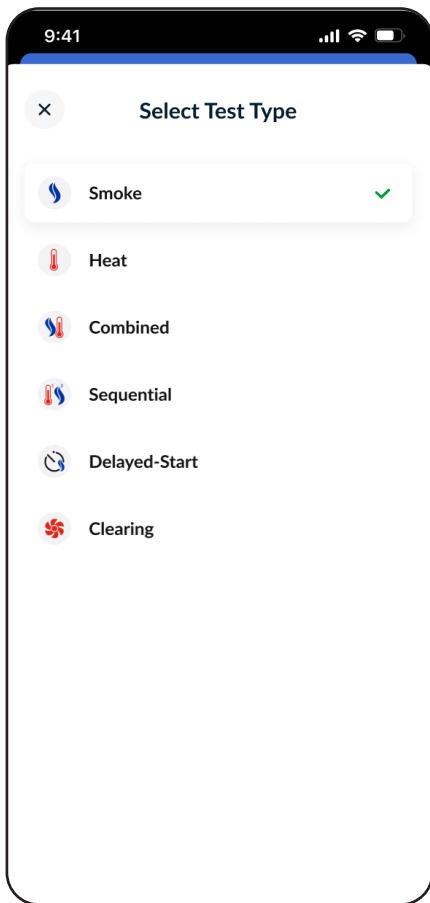

NOTE:

Hi-Heat mode and the Delayed-Start Delay duration can be selected after tapping the respective test mode.

10.2.2 Manual Clearing

After any test, including smoke activation, the XTR2 automatically performs clearing. Air is circulated around the detector, clearing any lingering smoke via the vent in the cup. You can perform manual Clearing if you want to further mitigate the chance of detector re-activation.

Select 'Clearing' from the Test Type menu (Fig. 45). Once selected, the XTR2 status LED's will change to solid white. Next, insert the detector into the XTR2 cup to begin.

10.3 Filter

Premium devices have access to the filter feature to help organise assets within the floor walk screen.

Simply tap on the desired filters to select them, then tap 'Save Filter'. The active filters can then be seen inside the filter button e.g (3). (Fig. 46)

To reset filters, return to this screen and tap 'Clear Filter'.

Figure 46

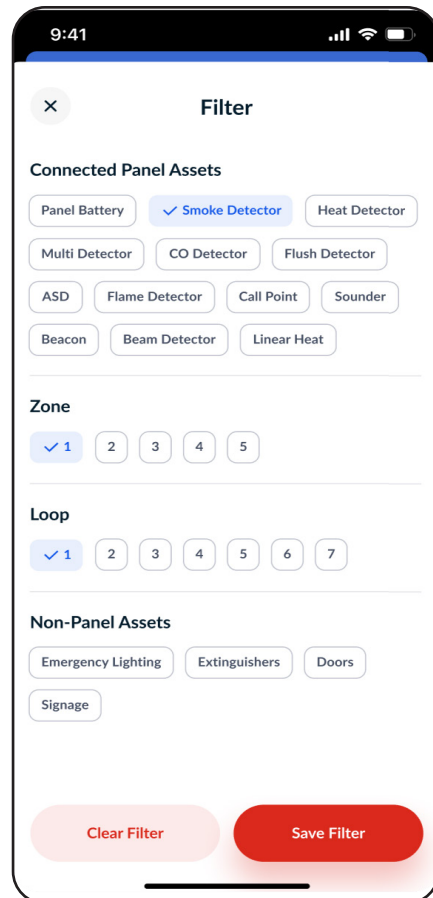

10.4 Changing Alarm Detection Mode

To change alarm detection mode, tap “Alarm Signal” and choose between Solid LED, Flashing LED, or Visual Check modes. (Fig. 47)

Figure 47

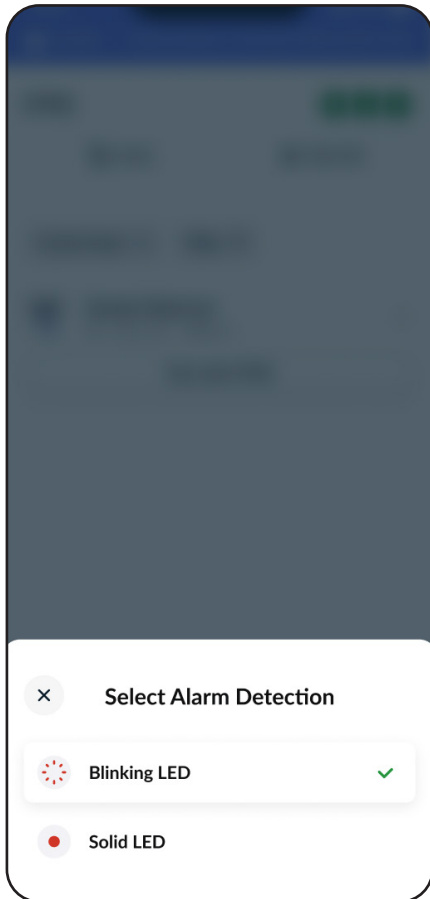

NOTE:

The XTR2 detects the test result through a number of LED sensors in the cup. Different detector brands and models have varying LEDs and activation patterns. Test Connected Panel Assets if they are NOT configured to the Fire Panel being tested.

- ✔ Select the appropriate detection mode based on the detector type.

10.5 Reconnect Your Device

If your XTR2 moves out of Bluetooth range or is turned off during the job you will see the No Device state in the app.

Simply tap ‘Connect Device’ to reconnect your XTR2. (Fig.48)

Figure 48

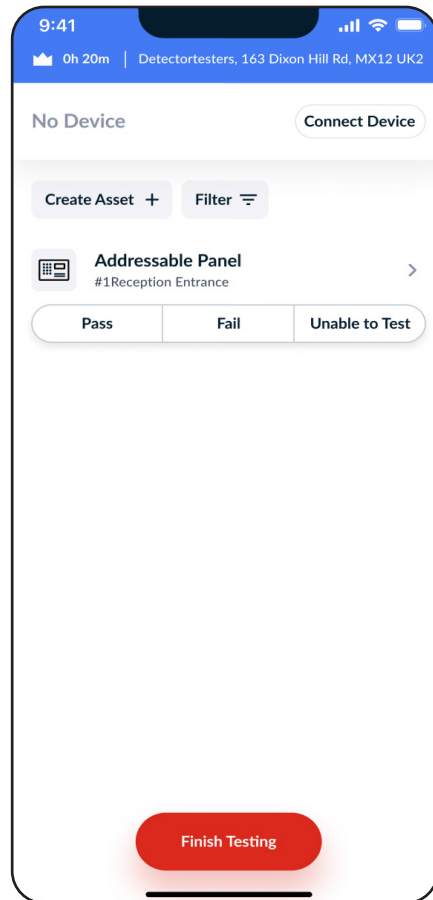

NOTE:

It is possible to reconnect to a different XTR2 device than was used to start the job.

DT CONNECT APP: XTR2 TEST RESULT CAPTURE

11.1 XTR2 Test Result Capture

The XTR2 will automatically start a test when a point-detector is fed into the tester cup and the LED is detected. Then, a 'Test In Progress' placeholder row will appear in the Test Log while waiting to receive the result (Fig. 49).

The XTR2 will continue testing using the selected mode until it detects an LED activation, indicating a PASS. If the 2-minute timeout is reached, the test will result in a FAIL. If the XTR2 is removed during testing, the test will be marked as ABORTED.

Additionally, Delayed-Start Testing and Visual Check Mode follow a manual testing procedure, which will be explained in the following sections.

IMPORTANT:

If the XTR2 is not detecting an activated detector you may need to re-configure alarm detection modes. (see section 11.3)

Figure 49

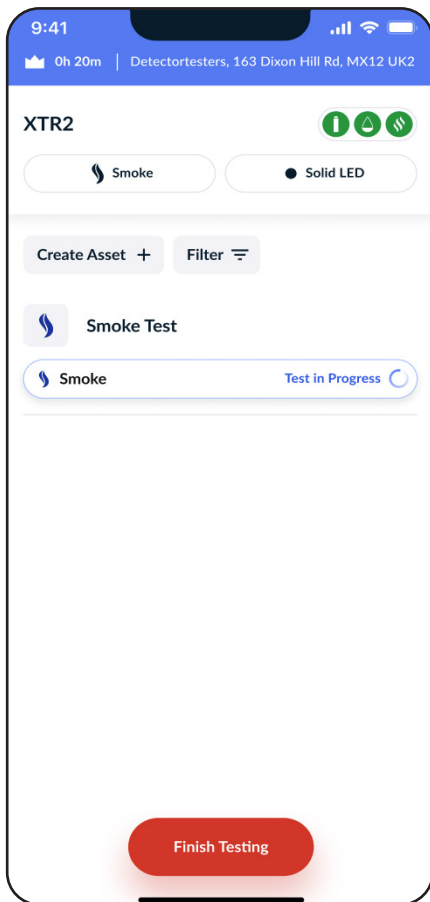

11.2.1 PASS Result - Free Devices

Devices with Free Membership will immediately see the PASS result once it is received from the XTR2. The result will be highlighted in green with corresponding date and timestamp to show it is complete. (Fig.50).

Figure 50

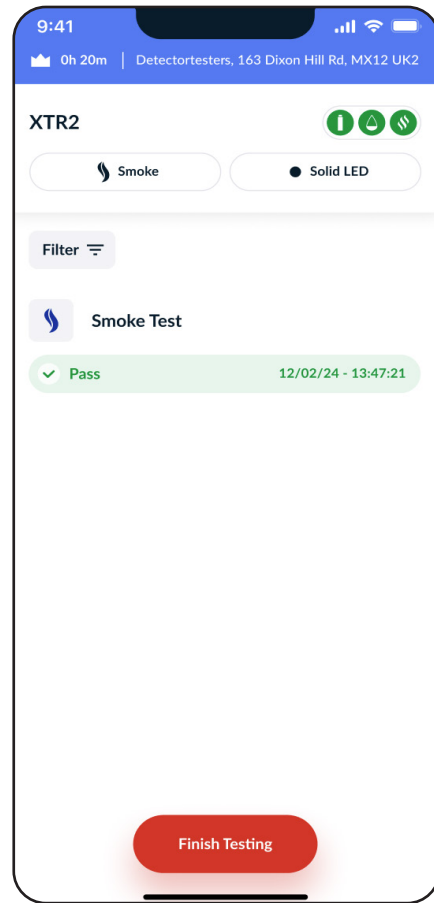

NOTE:

Free devices ONLY have the ability to capture the test result, whereas Premium devices have the ability to create assets by entering location details.

11.2.2 PASS Result - Premium Devices

If the XTR2 detects LED activation, this will indicate a PASS result. The result, date, and timestamp will then update in the app. Devices with **Premium Membership** will then have the opportunity to enter asset details on the Create New Asset screen. Ensure you enter asset details accurately to aid in future identification. (Fig. 51)

- When an **Addressable Panel** is selected, the **Loop and Address** fields will be visible when creating assets.
- For a Conventional Panel, only the **Location and Zone** fields are required for asset creation.

Creation of an asset requires either **Location OR Loop & Address** (for Addressable Panels). For Location, it is recommended to enter a short 2-3 word description of the room the asset is installed.

Tap 'Save Details' to return to the Floor Walk Screen. If Asset criteria have been met, you will find your new asset recorded in the Test Log below, along with an update in icon and name. Simply tap the row if you wish to edit asset or test details later.

Figure 51

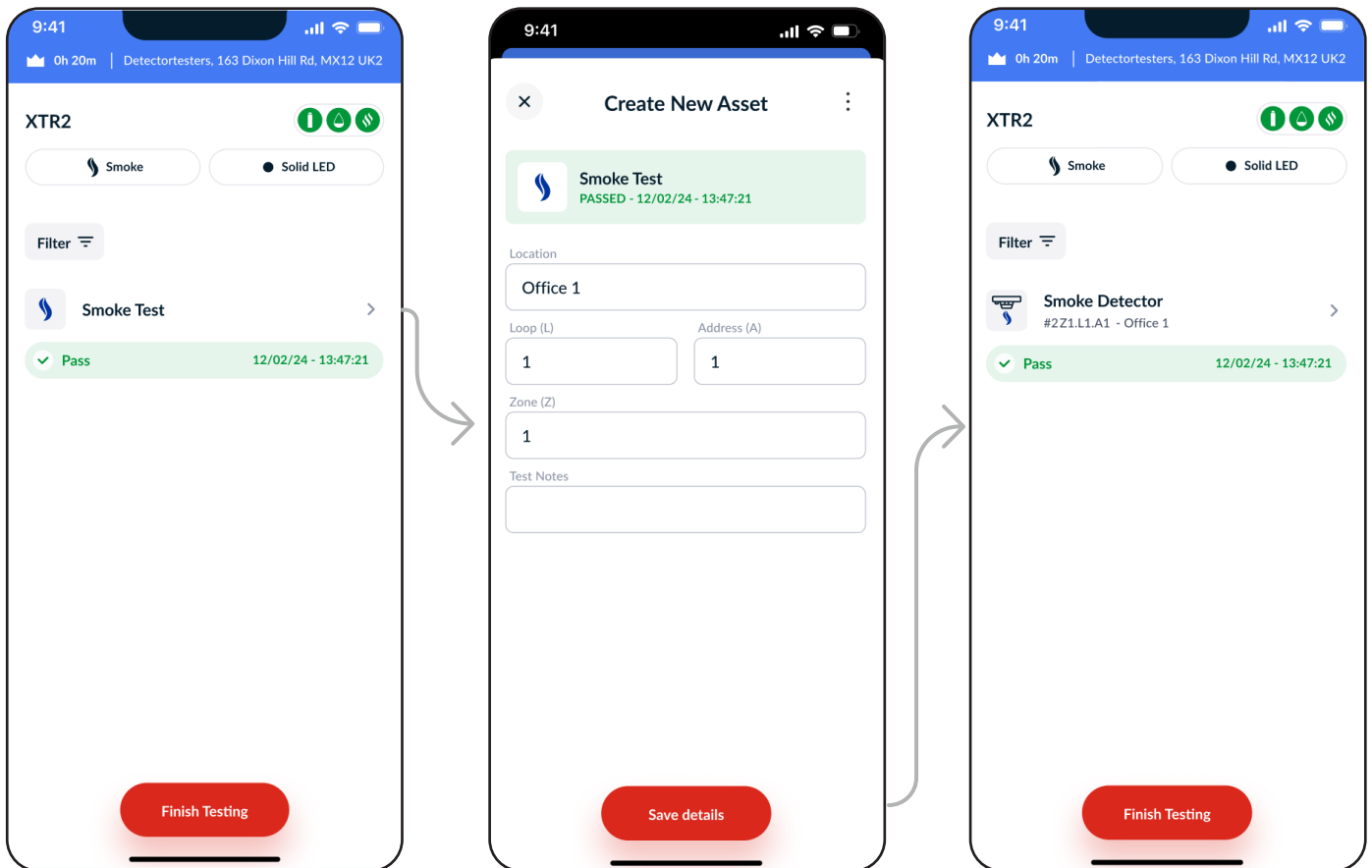

NOTE:
Creating an asset requires either a Location or both Loop & Address (for Addressable Panels).

11.3.1 FAIL Result - Free Devices

If the XTR2 does not detect LED activation after 2 minutes, the result will be marked as a FAIL. The result, date, and timestamp will then update in the app and be highlighted in RED.

Devices with Free Membership will immediately be prompted to enter a Test Note on the Test Details Page. Use this field to identify issues and propose solutions. (Fig. 52)

Tap 'Save Details' to return to the Floor Walk screen. A Test Note is mandatory for FAILED results. If left empty, users will not be able to proceed past the Floor Walk screen.

Figure 52

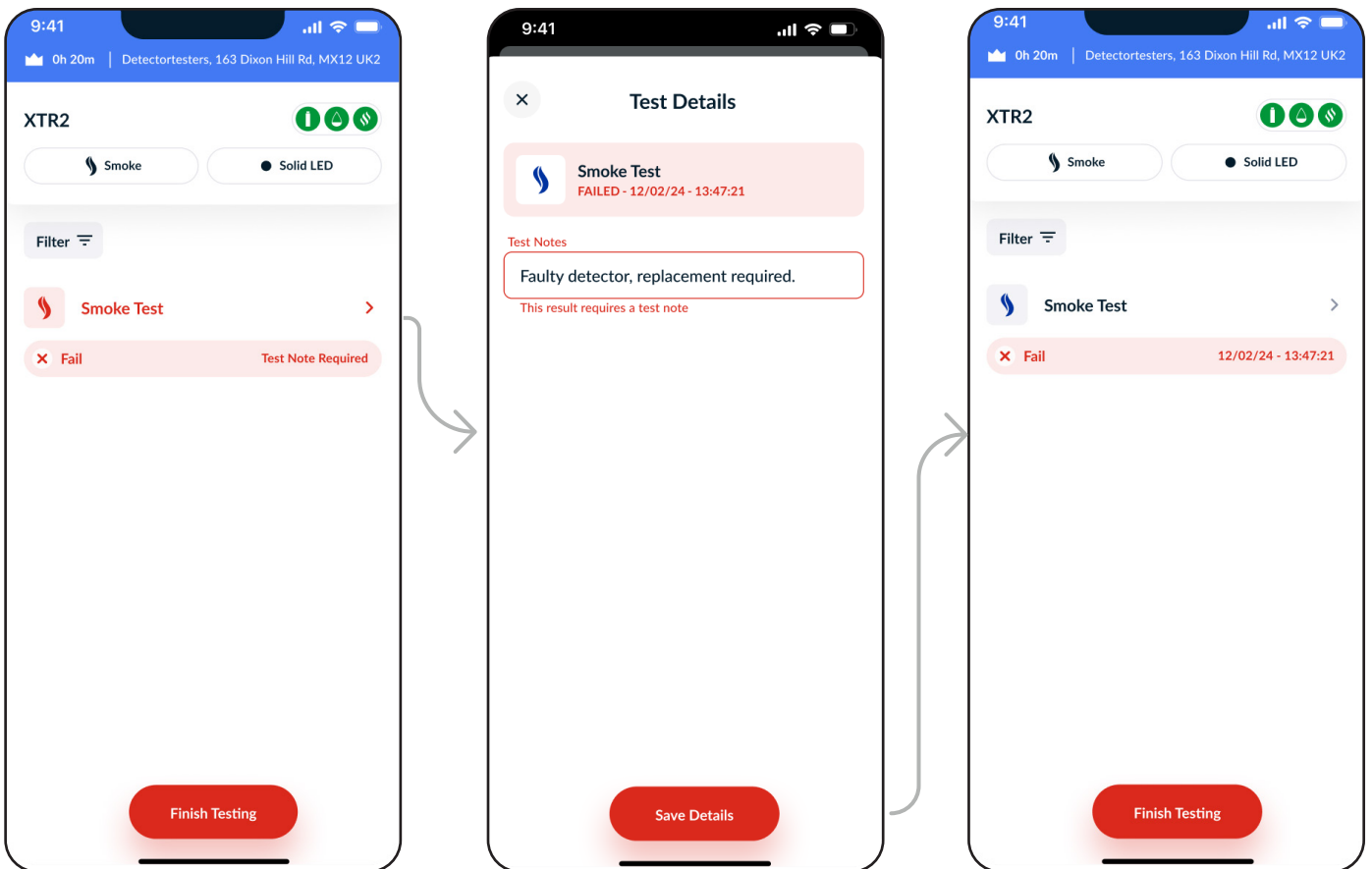

11.3.2 FAIL Result - Premium Devices

When a FAIL result is received, devices with **Premium Membership** will proceed to the Create New Asset page, similar to previous steps. As with **Free Membership** devices, the **Test Notes** field is mandatory. Use this field to identify issues and propose solutions. (Fig. 53)

Tap 'Save Details' to return to the Floor Walk Screen. If the **Test Notes** field is left empty, the row will be highlighted in red, displaying a 'Test Note Required' error message. All errors must be rectified before continuing beyond the Floor Walk.

Figure 53

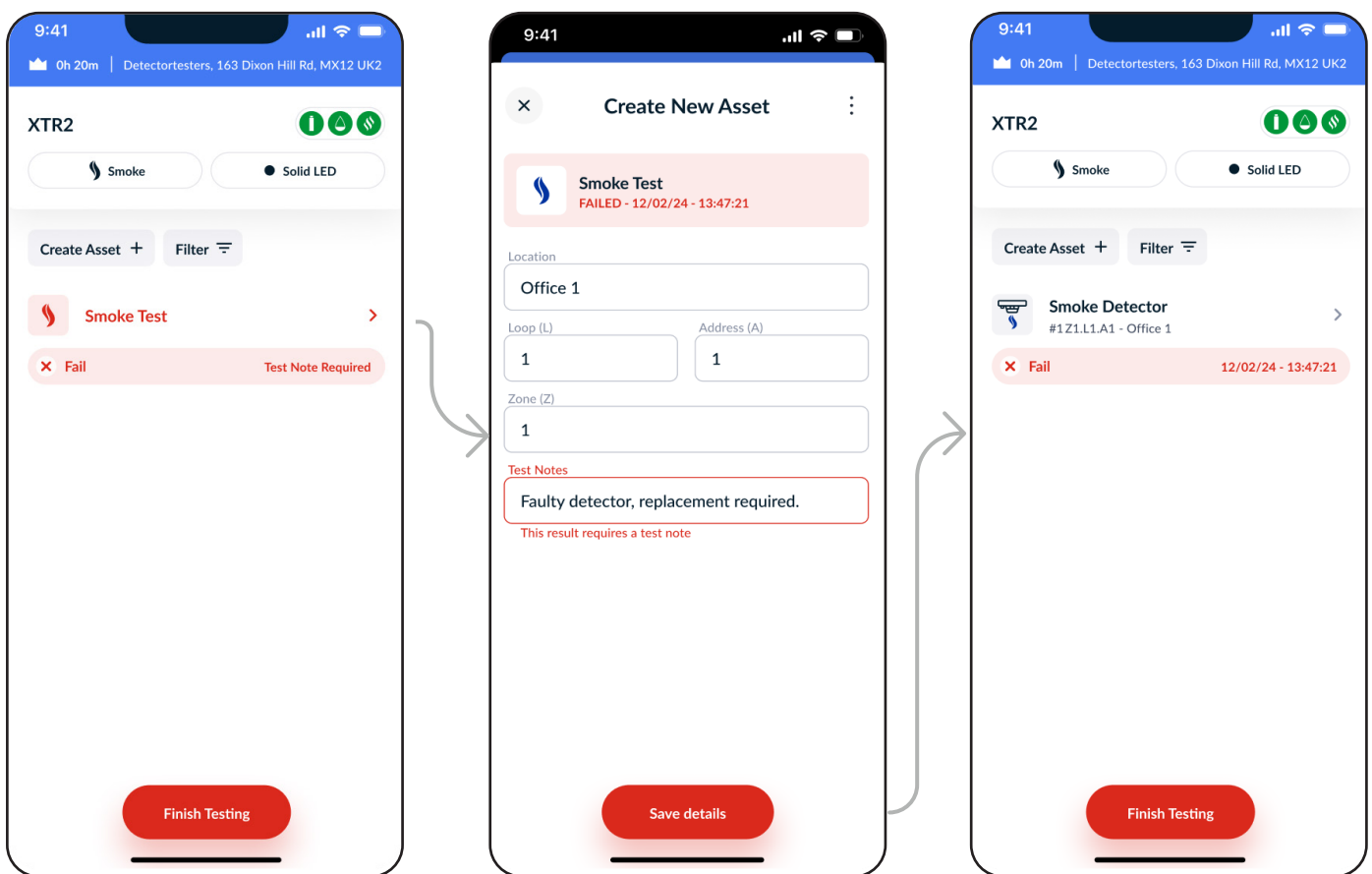

11.4.1 ABORTED Result

An active test can be aborted before completion by removing the detector and gently lowering the XTR2. The app will indicate the test was aborted and a prompt will appear with options enter a manual result (Fig.54).

Figure 54

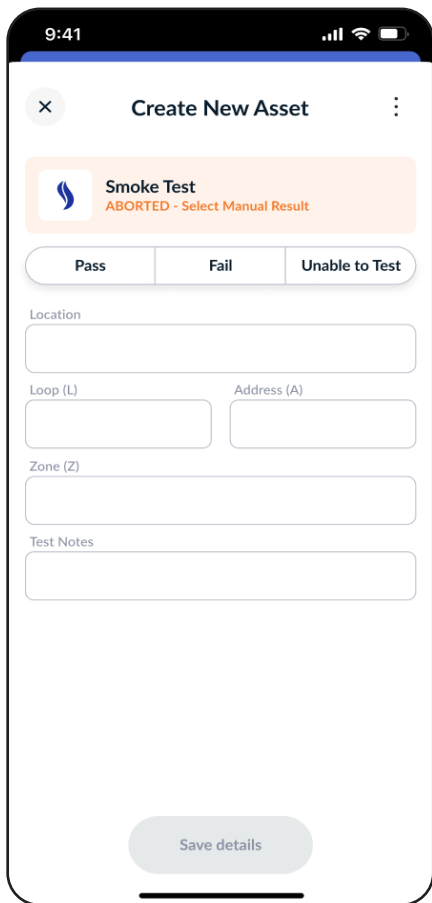

NOTE:

If you are certain a detector is faulty, this method can be used to enter a failed result without waiting for the 2-minute timeout.

11.4.2 ABORTED Result - Free Devices

If 'Enter Result' is selected, devices with **Free Membership** will be directed to the Test Details page. Since the XTR2 did not receive a result, the app prompts the user to enter a manual result.

FAILED and **UNABLE TO TEST** results require a Test Note, similar to automatically failed results. (Fig.55).

ABORTED tests without a selected result will appear as an **error** on the **Floor Walk** screen. All errors must be resolved before proceeding.

Figure 55

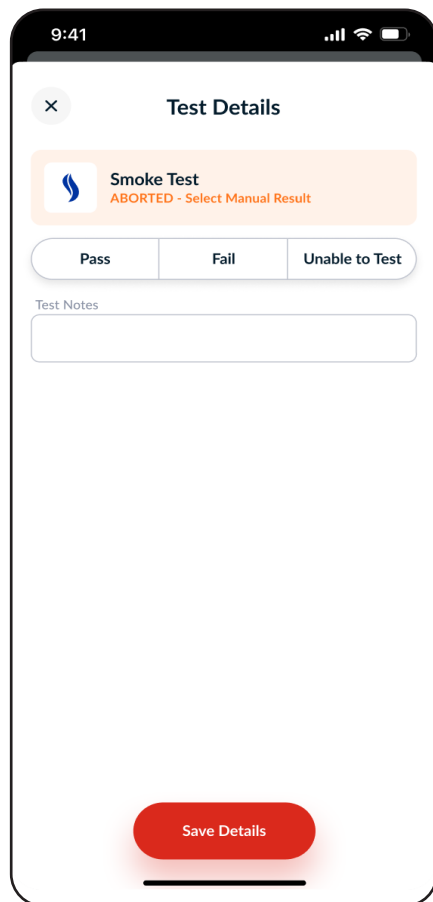

11.4.3 ABORTED Result - Premium Devices

If 'Enter Result' is selected, devices with **Premium Membership** will navigate to the Create New Asset page. Since the XTR2 did not receive a result, the app prompts the user to enter a manual result..

As with previous steps, **FAILED** and **UNABLE TO TEST** results require a Test Note, similar to automatically failed results.(Fig.56).

ABORTED tests without a selected result will appear as an error on the **Floor Walk screen**. All errors must be resolved before proceeding.

Figure 56

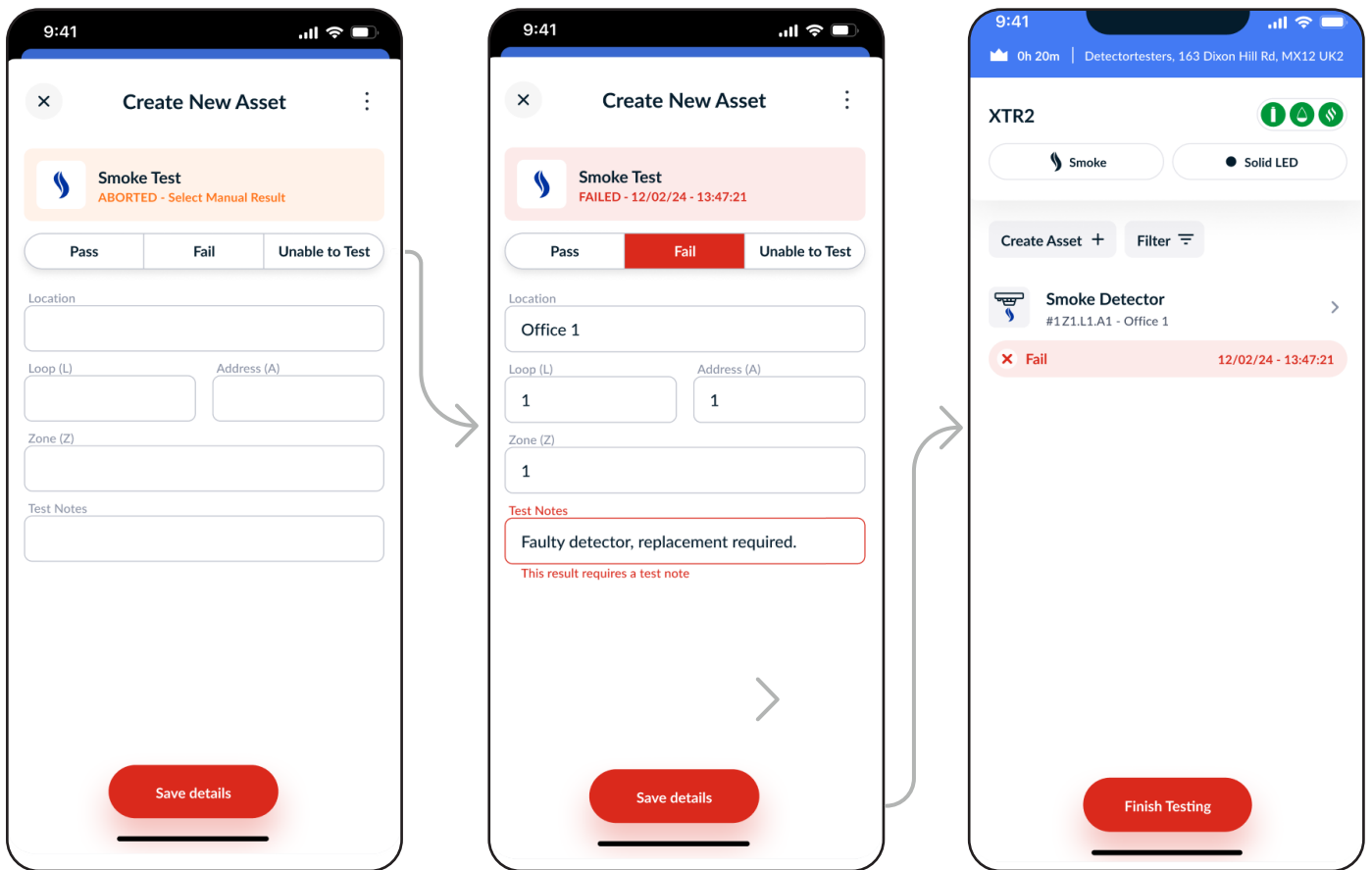

11.5.1 Using Delayed-Start Test Mode

ASD systems and Flush Detectors can be tested using **Delayed-Start test mode** with the **ASD Adaptor** (Product Code: TESTI-FIRE-ADAP-001). Refer to the user guide for instructions on fitting the adapter to the XTR2 cup.

Once the ASD adaptor is installed, change the test mode to Delayed-Start, then select a delay duration of 5, 20, or 40 seconds. Tap 'Start Test' when you are ready. Position your XTR2 and, after the delay period, smoke will disperse for 20 seconds. You will then be prompted to enter a result manually in either the app or on the XTR2. (Fig. 57)

Refer to Section 6.2 for more details.

Figure 57

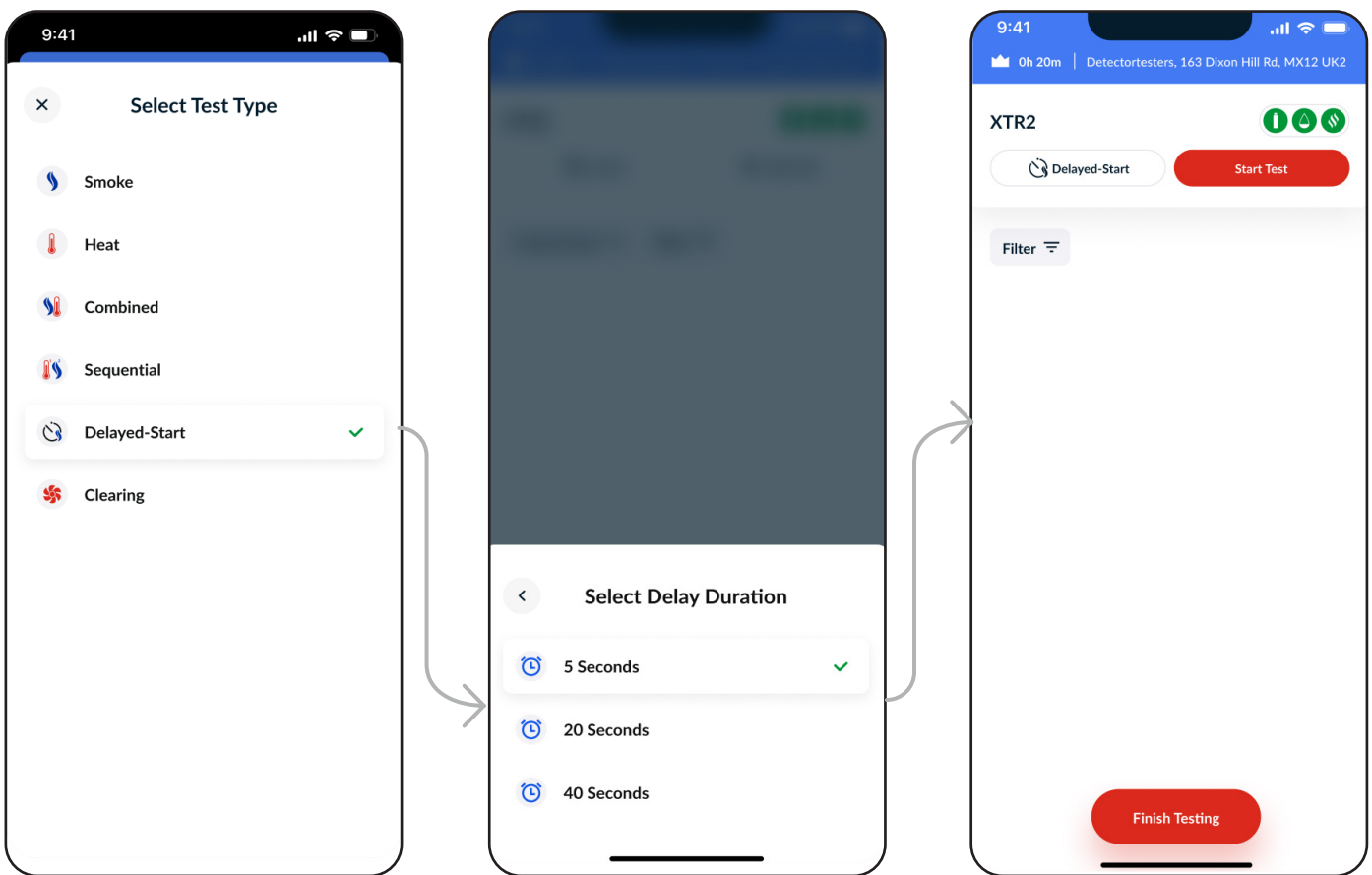

11.5.2 Manual Result Selection

Since the XTR2 cup cannot detect activation with ASD and Flat Detectors, the user must enter a manual result based on a **visual inspection**.

Once the **Delayed-Start test** has finished, the app will display a pop-up prompting you to enter a manual result: **PASS**, **FAIL**, or **UNABLE TO TEST** (Fig. 58).

For devices with **Free Membership**, your Delayed-Start result will be shown in the Floor Walk Test Log (Fig. 59).

As with other results, selecting **FAIL** or **UNABLE TO TEST** will require the user to enter a mandatory test note.

Figure 58

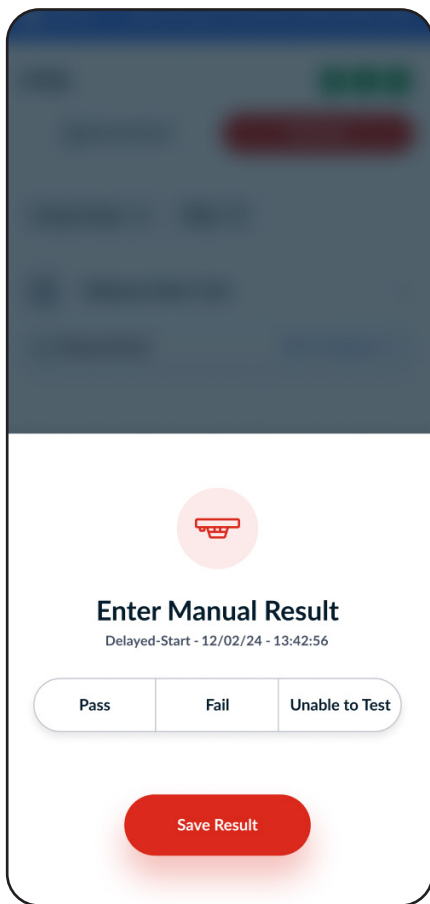
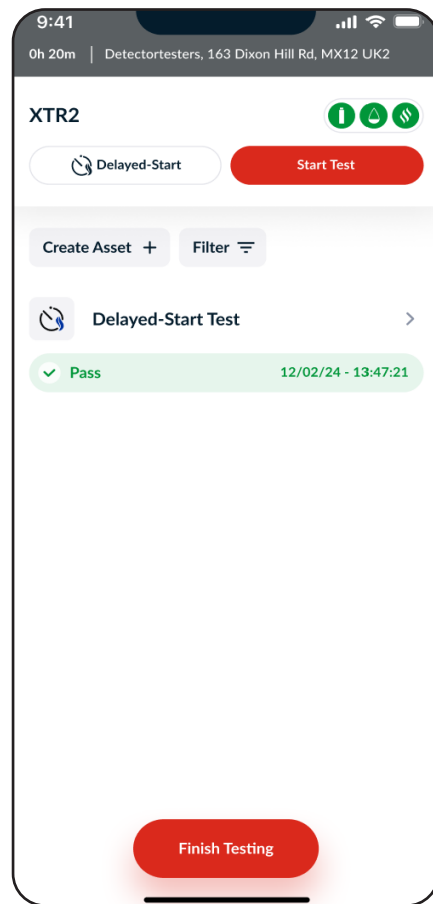

Figure 59



11.5.3 Delayed Start Result - Premium Devices

Devices with Premium Membership can enter , similar to automatic test results.

Delayed-Start tests allow users to select an **Asset Type** from a dropdown menu, with options including **ASD** and **Flush Detector**.

Once saved, your **Delayed-Start result** will appear in the **Floor Walk Test Log**.

If **FAIL** or **UNABLE TO TEST** is selected, users must enter a mandatory **test note** to proceed.

Figure 60

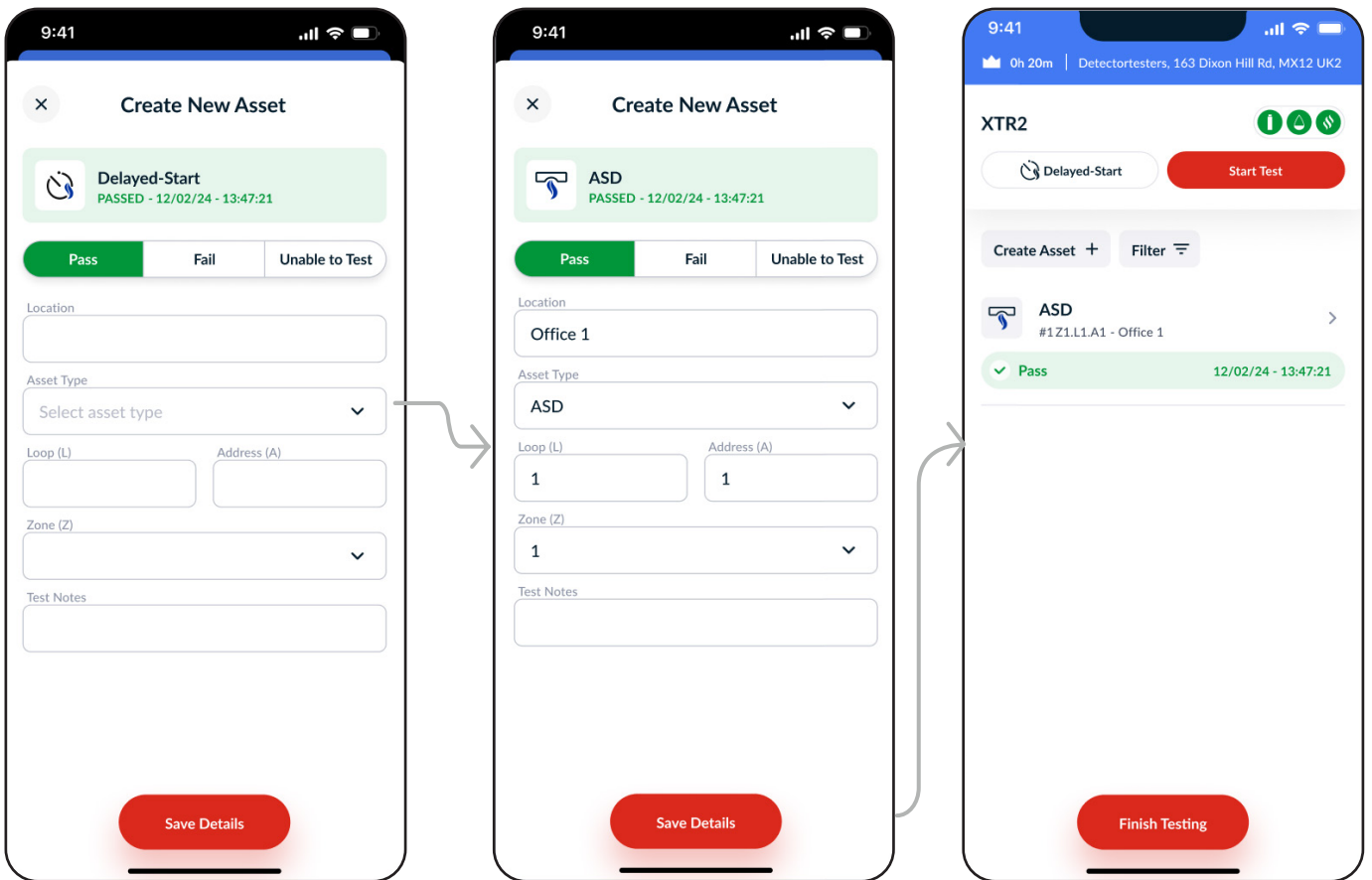

DT CONNECT APP: MANUAL ASSET CREATION

12.1 Manual Asset Creation

Devices with **Premium Membership** can tap 'Create Assets' on the **Floor Walk** screen to access the **Create Asset** page. This allows engineers to manually record test results for a wider range of assets beyond the XTR2's testing capabilities.

Connected Panel Assets: These cover the most common assets configured into a **Fire Panel System**.

Non-Panel Assets: These are not part of a **Fire Panel** but exist independently as part of a building's **fire safety measures**.

Assets **not tested** by the XTR2 must be tested manually using the [Pass | Fail | Unable-to-Test] options. Once a test result is determined, the engineer can enter the result, asset details, and test notes. (Fig. 61)

Figure 61

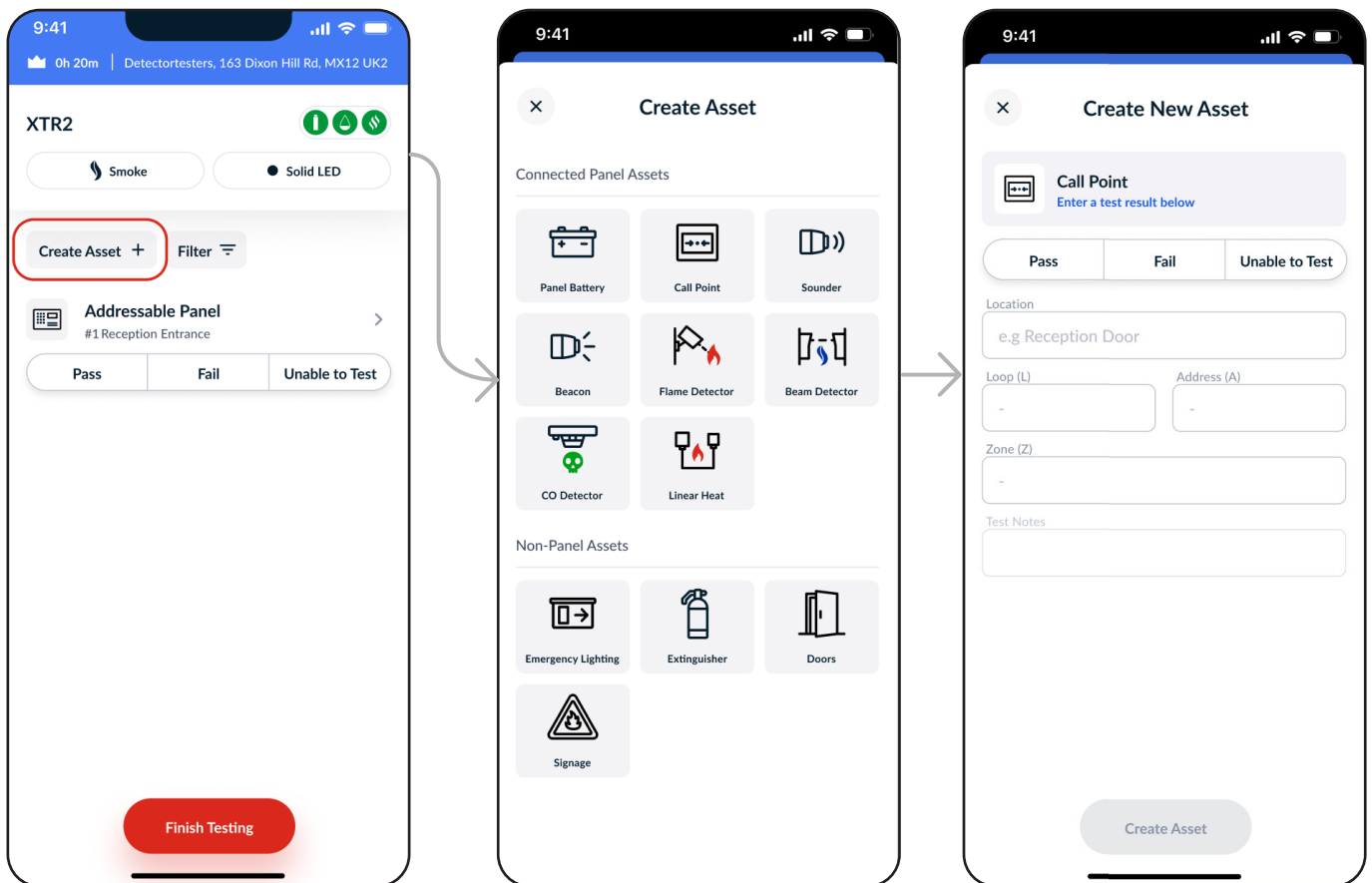

13

DT CONNECT APP: MANAGING AND DELETING ASSETS

The Asset Details menu provides several actions to help with managing Assets and Tests.

13.1 Delete Test Result for Re-testing

Deleting a test result removes the existing result and allows for a re-test on the Floor Walk screen. (Fig. 62)

To delete a test result:

1. Tap on the asset to open the Asset Details screen.
2. Tap the menu in the top-right.
3. Select 'Delete Test Result'.
4. Proceed to re-test the asset.

Figure 62

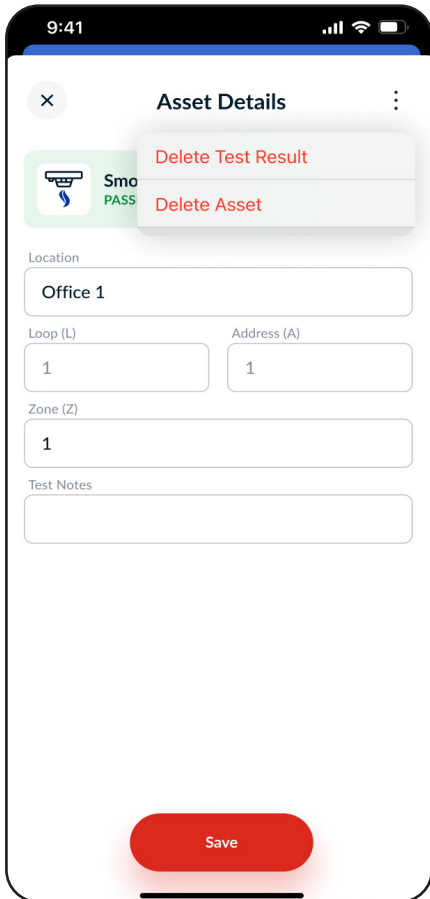

13.2.1 Delete Asset

Deleting an asset will remove it from both the Job and Asset List, including the Site Asset List accessed via the Cloud Portal.

Follow the previously outlined steps, then tap 'Delete Asset' (Fig. 62).

13.2.2 Delete Panel Asset

Users can also delete a panel asset in the same way as a regular asset.

IMPORTANT:

- Deleting a panel asset will also delete ALL connected panel assets (e.g., Detectors, Beacons, Call Points).
- This action cannot be undone. We recommend deleting assets with caution.

14

DT CONNECT APP: EXISTING ASSET TESTING

With Premium Membership, devices can test existing sites and assets.

Since assets have already been created, testing can be conducted more efficiently.

To test assets, there are two available methods:

14.1 Manual Test Result

Manual result entry is required for assets that cannot be tested via the XTR2. Examples include Call Points, CO Detectors, and Addressable Panels (Fig. 80).

- Tap **PASS**, **FAIL**, or **UNABLE TO TEST** in the test segment.
- Selecting **FAIL** or **UNABLE TO TEST** will prompt the user to enter a **Test Note**. (Fig. 63)

Figure 63

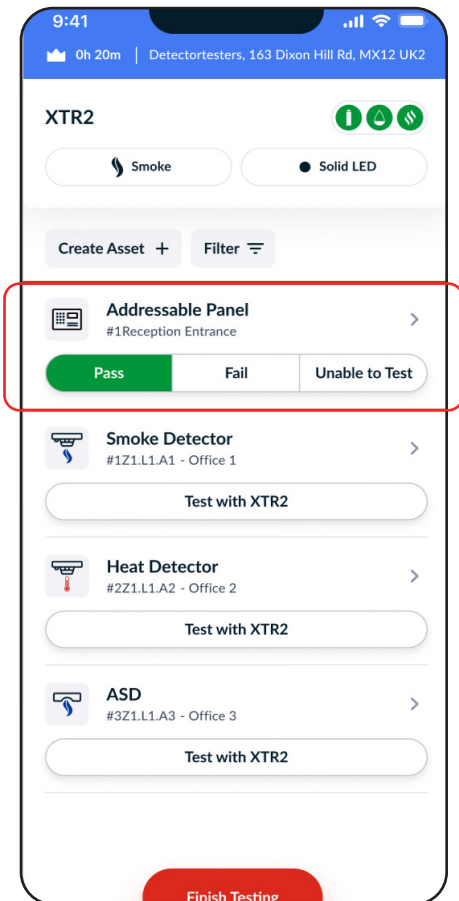

14.2 Test with XTR2

Testing an existing asset with the XTR2 requires the user to first select the desired asset using the 'Test with XTR2' button (Fig. 64).

- Once selected, the asset will enter the 'Begin Testing' state.
- The XTR2 will automatically prime itself with the appropriate test type.
- Any test result received from the XTR2 while in this state will be linked to the selected asset.
- To deselect an asset, tap the 'X' next to 'Begin Testing', or select another asset to test.

This method of testing requires active use of the app, but dramatically speeds up configuration time and improves accuracy when recording test results against assets.

Figure 64

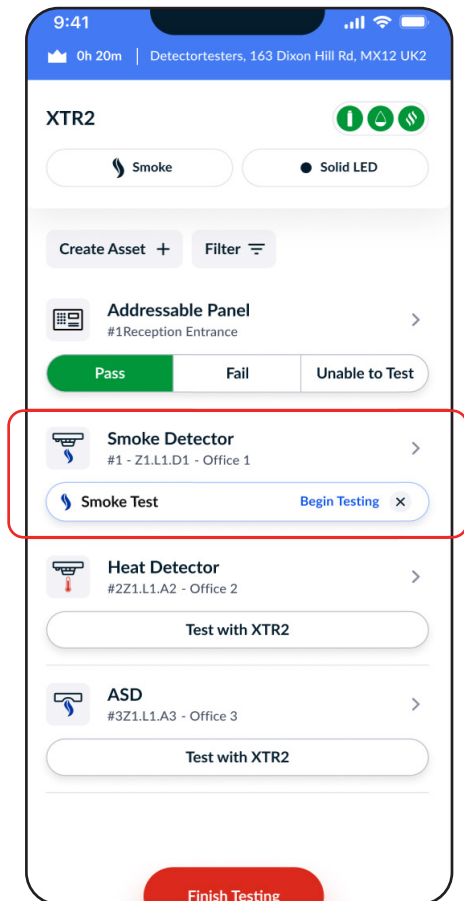

DT CONNECT APP: JOB COMPLETION

15.1 Job Completion

The Job Summary page includes a breakdown of testing completed.

- The 'Details' tab contains a summary of tests captured, assets tested, and job notes. Any notes entered here will appear in the Job Report PDF seen by the client.
- The 'Test Log' tab provides a chronological record of all completed tests, including reconciled test results.
- The 'Panel Reconciliation' feature allows users to verify tests against the Fire Panel Event Log.

After reviewing, tap 'Complete Job' to finalise the job (Fig. 65).

Figure 65

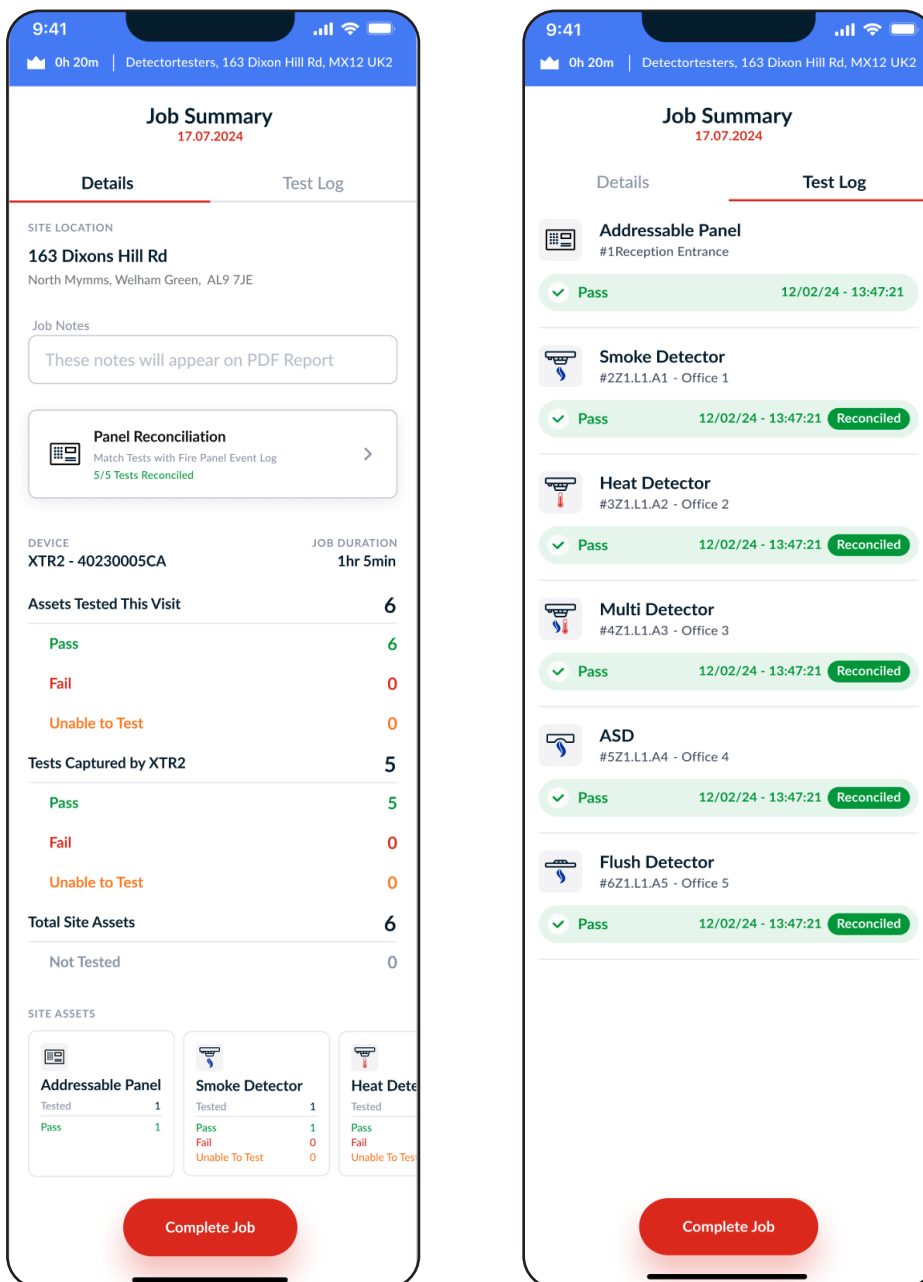

15.2 Panel Reconciliation

Users testing an Addressable Fire Panel with a Premium Membership device will have access to the Panel Reconciliation feature in the Job Summary (Fig. 66).

This process provides the client with an additional layer of proof in the PDF Report.

During Panel Reconciliation, the system identifies any tests or assets that should have triggered an event on the Fire Panel during testing.

The Estimated Alarm Time is calculated based on the Panel Time logged during setup, accounting for potential time discrepancies.

This screen includes all asset location input fields, allowing you to enter accurate asset information from the Fire Panel if it has not yet been recorded.

Steps to Perform Panel Reconciliation:

1. Compare the Estimated Alarm Time with the Fire Panel Event Log.
2. If timestamps match, tap 'ALARM' – this confirms that the test matches the Fire Panel Event Log correctly.
3. If no event appears at the timestamp, tap 'NO ALARM' – this may indicate an issue with the test or the detector being tested.
4. Enter any missing asset details.
5. Tap 'Submit', then proceed through all reconcilable tests.
6. Review tests in the 'Reconcile Summary'.
7. Tap 'Finish' to complete the process.

Figure 66

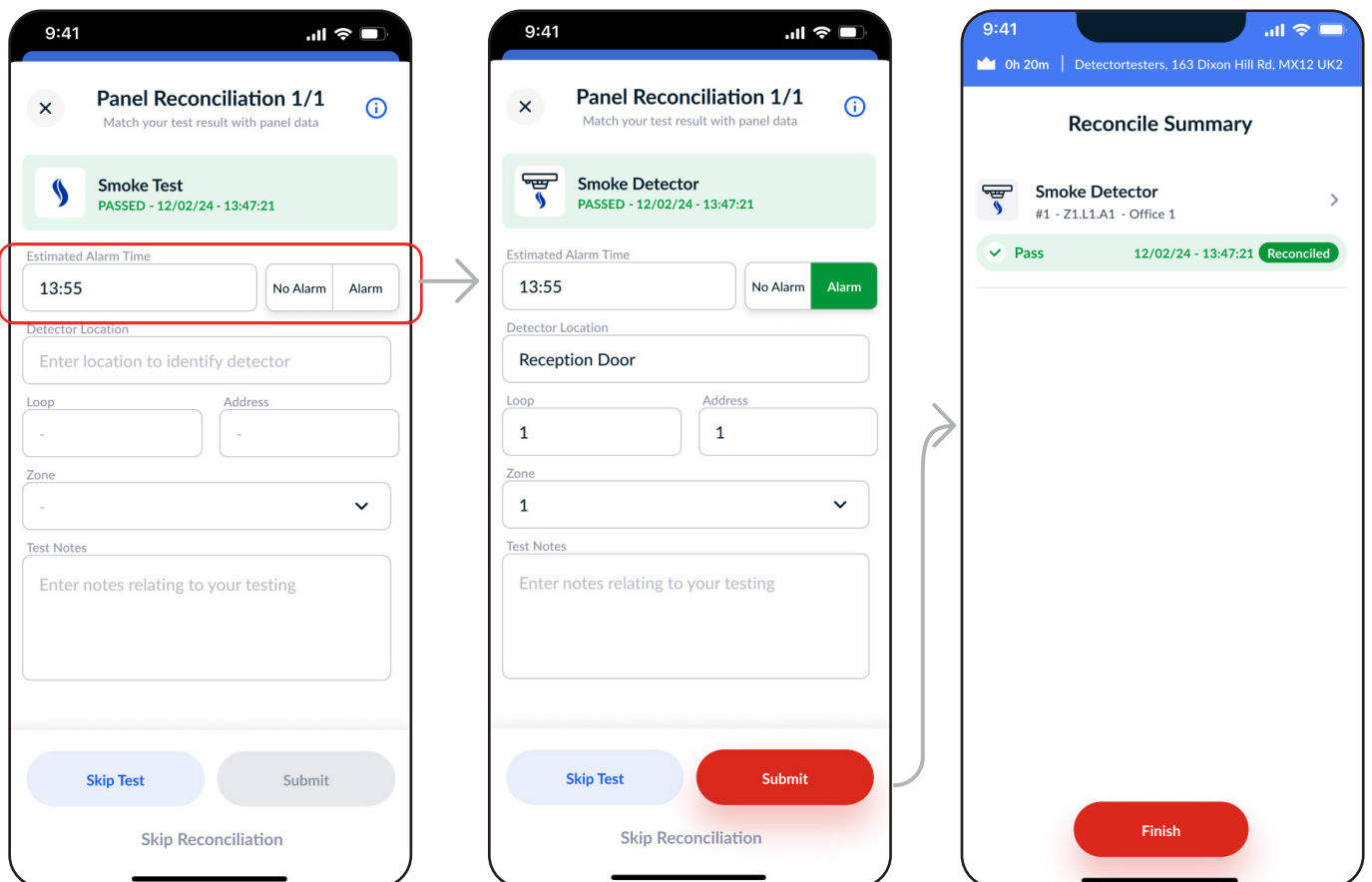

15.3 Signature Collection

Devices with a Premium Subscription have the option to collect a client signature before closing the job.

If required, the client can sign off the job by entering their name and signature before tapping 'Submit' (Fig. 67).

The client's signature will be included in the final PDF Report, providing proof of test completion for the engineer.

Figure 67



15.4 Completed Jobs

Once completed, your job will be uploaded to the cloud, and any new assets will be added to the Site Asset List.

You can find your completed job in the Job History section on the Dashboard (Fig. 68).

Figure 68

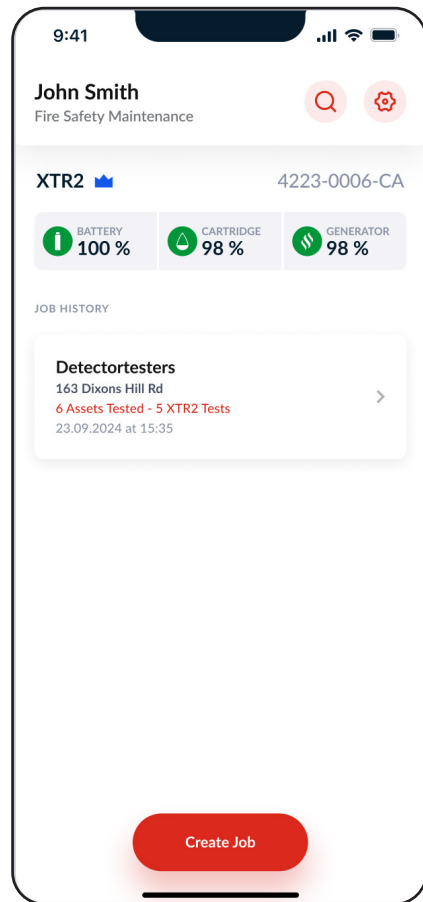

NOTE:

An internet connection is required to upload a completed job. If no internet connection is available, the job will be labeled 'Pending Upload' until connectivity is restored.

15.5 View Historical Job Summary

Once a Test Job is closed, it will be listed under 'Job History' on the Dashboard (Fig. 68).

To view a historical job summary, tap a job in Job History or use the search function (Fig. 69).

The 'Details' tab contains a summary of tests captured, assets tested, and job notes. Any notes entered here will appear in the Job Report PDF seen by the client.

The 'Test Log' tab provides a chronological record of all completed tests, including reconciled test results.

Figure 69

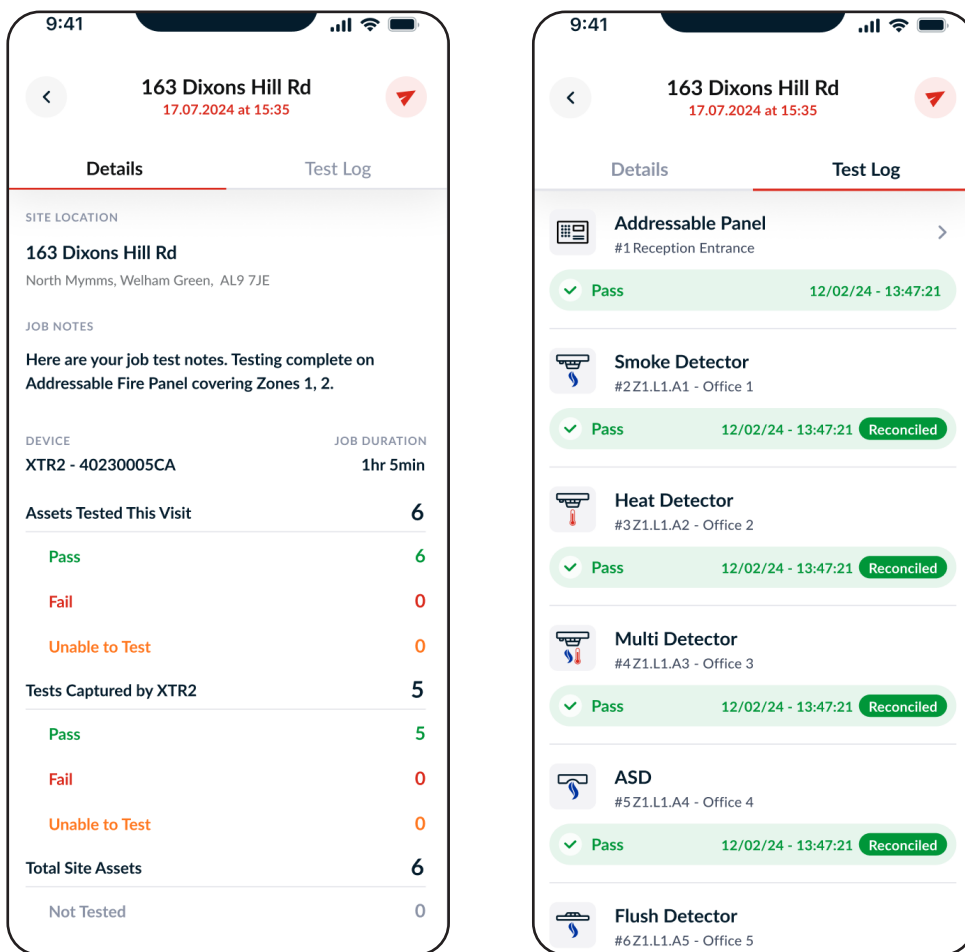

15.6 Share Test Job

Jobs created with Premium Devices can generate and share a PDF report with the client via email.

Tap the share icon in the top-right, enter the client's email, and tap 'Send' (Fig. 70).

Send Report: Enter an email address to receive the test report in PDF format.

Figure 70

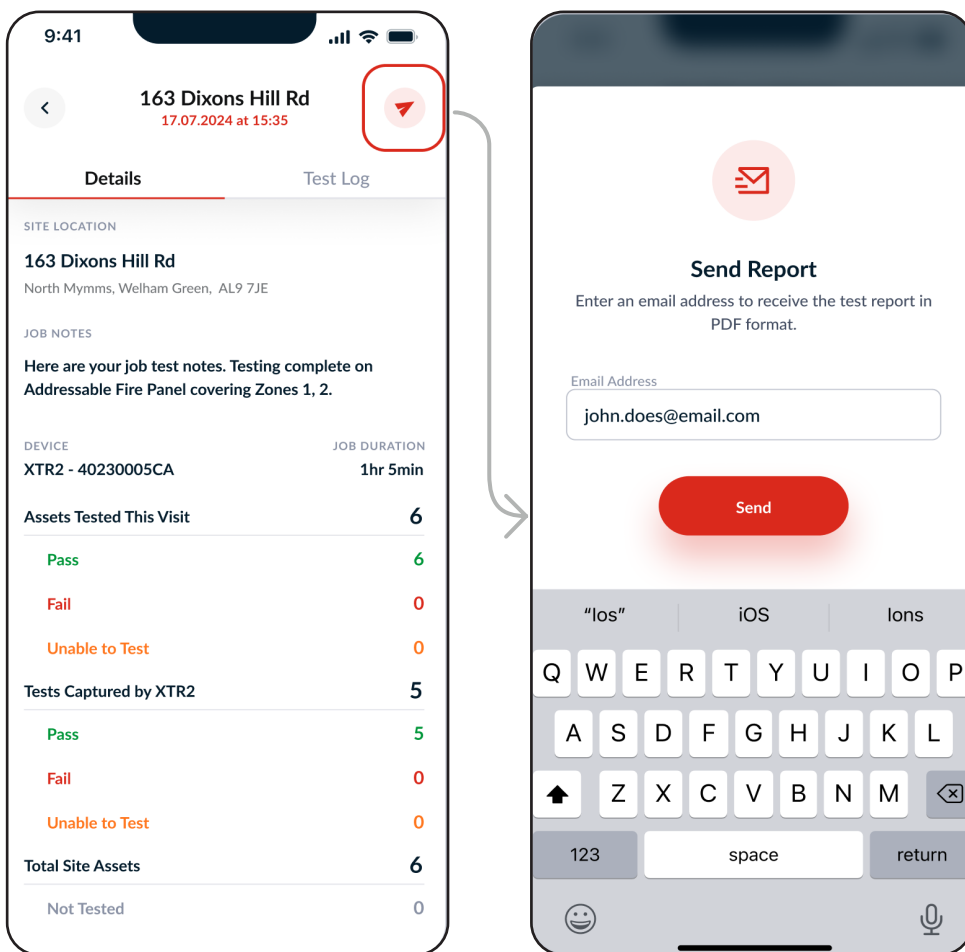

DT CONNECT APP: APP SETTINGS

16.1 App Settings Menu

The Settings menu provides access to account information, app settings and troubleshooting information (Fig. 71)

Figure 71

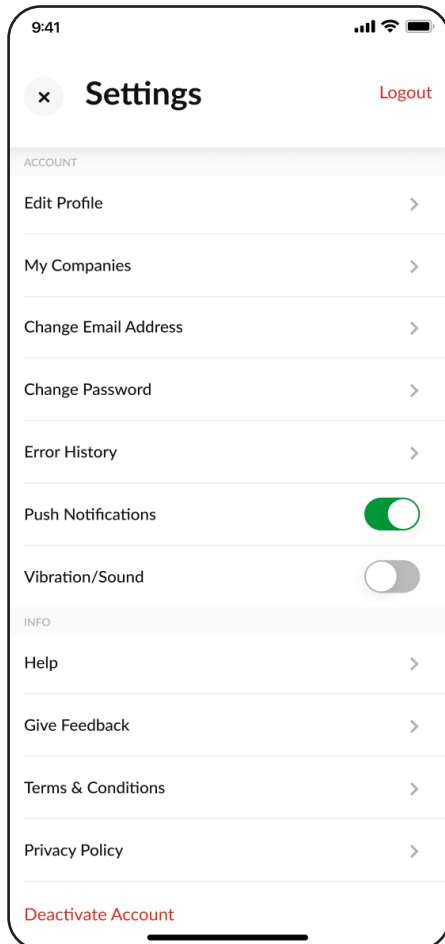

16.1.1 Edit Profile

Select this option to update account information including first name, last name and country of use.

16.1.2 My Companies

Select this option to view the companies the account is associated with and to connect a new company using a company registration code.

16.1.3 Change Email Address

Select this option to update the email address for the account. You will be required to enter your old and new email address.

16.1.4 Change Password

Select this option to update the password for the account. You will need to enter your old and new password.

16.1.5 Error History

This menu includes a list of all device errors and enables direct contact with Detectortesters Support by phone or email.

16.1.6 Push Notifications

Enable this option to receive push notifications from the DT Connect app on your mobile device.

16.1.7 Vibration/Sound

Enable this option for vibration and sounds from the DT Connect app on your mobile device.

16.1.8 Help

The DT Connect app includes access to a range of help and support videos so you can make the most of XTR2. To access the content, tap the settings icon in the top right hand corner from the home screen and select the "Help" option.

A manual purge may be required when the unit has not been used for a period of time, when in cold conditions, a new generator has been installed or in the case of a significant drop in performance. To perform a manual purge, tap the manual purge option from the bottom of the help menu.

NOTE:

A manual purge should only be carried out in a well ventilated area (see Section 5.8 Manual Purge).

16.1.9 Give Feedback

Select this option to give us your feedback on the DT Connect app

16.1.10 Terms & Conditions

This menu allows you to view the latest Terms & Conditions for DT Connect

16.1.11 Privacy Policy

This menu allows you to view the latest Privacy Policy from Detectortesters

16.1.12 Deactivate Account

Select this option to deactivate your account. This action is irreversible

CONSUMABLES AND ACCESSORIES

Consumables

TES3-3PACK-001	XTR2 Smoke Cartridges x3
TES3-6PACK-001	XTR2 Smoke Cartridges x6
TESTIFIRE-GEN-1PK-001	XTR2 Smoke Generator x1
TESTIFIRE-BP-001	XTR2 Lithium Ion Battery Pack x1

Accessories

TESTIFIRE-ADAP-001	XTR2 ASD Adaptor
TESTIFIRE-FA-001	XTR2 Heat Deflector

Spares

TESTIFIRE-CHAK-001	XTR2 Charger Kit
TESTIFIRE-CHA-001	XTR2 Battery Charge Cradle
TESTIFIRE-WPSU-001	XTR2 Mains Power Adaptor
TESTIFIRE-CPSU-001	XTR2 Car Power Adaptor
TESTIFIRE-USBC-001	XTR2 Charger lead (USB-C to USB-C)
TESTIFIRE-MEM-001	Replacement Membrane for XTR2
TESTIFIRE-MEML-001	XTR2 membrane (Large)
TESTIFIRE-SOP-001	Replacement Stand off Plate for XTR2

TROUBLESHOOTING

If when testing, a detector does not activate, the status LED's will display a triple red flash. If this occurs you should confirm the following:

1. The correct test mode is selected
2. The optical LED reader is configured to respond to the correct detector behaviour (solid or flashing, see section 5.9 Device Settings)

Repeat the test again up to 2 more times by removing and replacing the unit over the detector. If the detector still does not activate it may be faulty and need replacement.

Unit does not switch on

Remove the battery and check the charge indicator. If empty, recharge the battery. (Fig. 72).

Figure 72

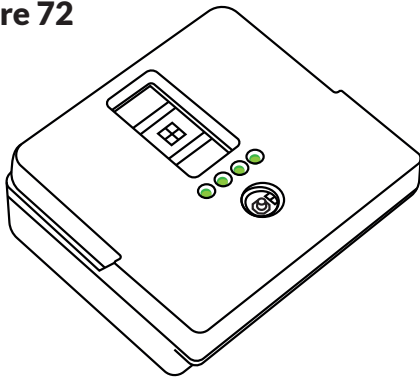

Smoke not being generated

If the fluid indicator is empty change the smoke cartridge. If the generator indicator is displayed change the generator. (Fig. 73).

Figure 73

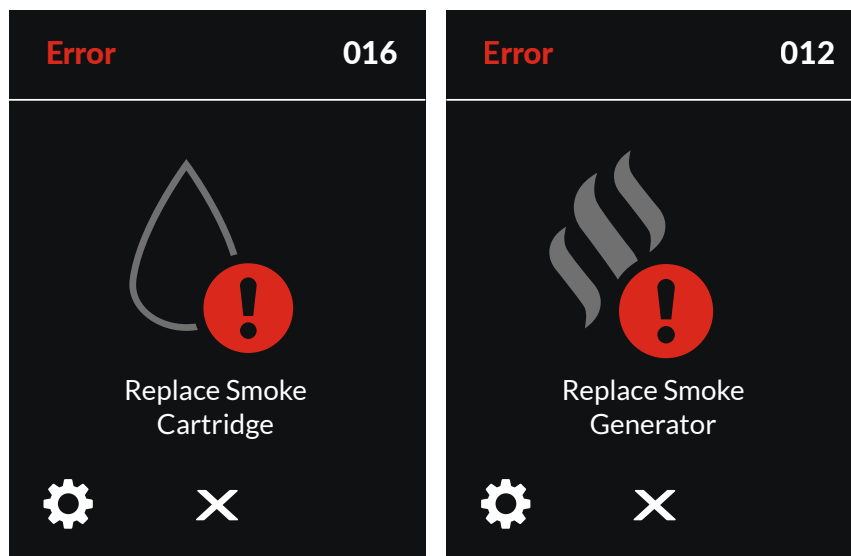

Fan is not rotating

Check for obstructions. Use an air duster to clear debris

The status LED's turn purple

A fault has occurred and an error code will be shown on the LCD display. Error codes represent a unique fault and require different actions to resolve. See section 11.1 for more detail on individual error codes and required actions.

1. Power the unit off and on again.
2. Power the unit off and remove the battery. Remove and re-insert the generator and check the PCB contacts for any debris. Wipe clean with a lint free cloth if necessary.
3. Check the fan moves freely, if not remove the smoke cartridge and generator from within XTR2. Fan faults may occur to due debris getting inside the unit. Carefully use an air duster and apply to the fan or rotate the fan gently. The use of an air duster normally frees the fan of debris. Re-insert the battery and power the unit on.
4. If the problems remain, please contact support@detectortesters.com

18.1 Device Error Codes

In the event of a system fault, XTR2 will display an error code on the LCD display. Every error code is unique and represents a different fault.

Error Code	Description	Required Action
1	Unit deactivated at first power on due to no connection to DT Connect App	Pair XTR2 to the DT Connect App
2	Unit deactivated by external command	Contact Product Support to reactivate
3	Fan jammed or stalled	Power the unit off. Check the fan moves freely, if not remove the smoke cartridge and generator. Use an air duster or rotate the fan gently
4	Fan rotating, but cannot be controlled to setpoint RPM	Power the unit off. Check the fan moves freely, if not remove the smoke cartridge and generator. Use an air duster or rotate the fan gently
6	Short circuit on heat element	Power the unit off. Remove the battery and wait 30 seconds. Reinsert the battery and retry
7	Heat element out of temperature range	Power the unit off. Remove the battery and wait 30 seconds. Reinsert the battery and retry
9	Short circuit on smoke element	Replace smoke generator
10	Smoke element out of temperature range	Replace smoke generator
11	Smoke generator not detected	Power the unit off. Remove the battery, smoke cartridge and smoke generator. Reassemble in reverse order and retry
12	Replace smoke generator	Replace smoke generator
15	Smoke cartridge not detected	Power the unit off. Remove the battery, smoke cartridge and smoke generator. Reassemble in reverse order and retry
16	Replace smoke cartridge	Replace smoke cartridge
19	No communications to sensor board	Power the unit off. Remove the battery and wait 30 seconds. Reinsert the battery and retry
20	IR sensor error	Power the unit off. Clean IR sensor and restart device
23	Ambient light level in cup too high to detect LED	Ambient light in cup too high for LED recognition
25	Unit powered but no coms to battery pack	Power the unit off. Remove the battery and wait 30 seconds. Reinsert the battery and retry
26	Battery not authenticated	Replace battery with approved XTR2 spares (see section 10)
30	Battery temperature out of limits	Battery temperature too high
31	Battery charge empty	Recharge battery
34	RTC not initialised	Pair XTR2 to the DT Connect App
37	Smoke element over current limit	Replace smoke generator
39	Heat element over current limit	Power the unit off. Remove the battery and wait 30 seconds. Reinsert the battery and retry
43	Bluetooth module error	Power the unit off. Remove the battery and wait 30 seconds. Reinsert the battery and retry
44	Smoke generator not authenticated	Replace smoke generator with approved XTR2 spares (see section 10)
45	Smoke cartridge not authenticated	Replace smoke cartridge with approved XTR2 spares (see section 10)
46	Cartridge Registration required	Register the smoke cartridge before use

19.1 Maintenance

The XTR2 unit contains no user serviceable parts. Do not disassemble. In the case of a build-up of dust or dirt on the surface of the product, wipe with a slightly damp lint-free cloth.

The area around the smoke/heat duct and within the cup should be cleaned periodically to remove any dirt or fluid.

This can also be done using a slightly damp lint-free cloth. Do not use detergents, cleaning materials or solvents such as petroleum spirit, benzene or methylated spirit to clean the product.

<https://detectortesters.com/troubleshooting>

19.2 Technical Information

<p>Operating features:</p>	<ul style="list-style-type: none"> • Electronic smoke stimulus • Heat stimulus (standard / hi-heat) • Automatic smoke clearing function • Optical sensors to automatically capture detector led alarm status • TFT-LCD full colour touch screen • Colour led user feedback up to 9m visual distance • Automatic torch in dark environment • Adjustable multi-position head • BT enabled to communicate with detectortesters-connect app • Optional subscription for premium features in the DT Connect app and Cloud Portal
<p>Safety features:</p>	<p>General safety features</p> <ul style="list-style-type: none"> • Auto-shutdown feature. If the unit is inactive for more than 10 minutes, the unit automatically shuts down which disconnects the control circuit from the battery pack. • All tests are time limited to 120 seconds. <p>Heater/smoke safety features:</p> <ul style="list-style-type: none"> • Microprocessor in-test temperature and voltage safety monitoring stops test in response to fault • INA230 current alert function stops test in response to fault • Fuse protection if heater/smoke element overheats <p>Battery pack safety features:</p> <ul style="list-style-type: none"> • The battery pack features safety circuits to prevent over temperature, over current, over charging and deep discharge conditions. • Microprocessor in-test temperature safety monitoring displays LCD warning and prevents further tests until battery cooldown • JEITA compliant charge cycle limiting charge current and voltage dependant on temperature
<p>Power source:</p>	<p>Lithium ion battery pack nominal 10.8v 35.1wh/3250mah, with USB-C connection to charging cradle</p>
<p>Battery charging time:</p>	<p>50% charge 23°C: Less than 1 hour</p> <p>Fully charged: 5°C = 3 hours 23°C = 2 hours 40°C = 3 hours</p>
<p>Power consumption:</p>	<p>Dependent on mode of use:</p> <p>Smoke testing: <0.5A rms Heat testing: 4-6A rms</p> <p>N.B. Power consumption refers only to the duration of the actual test and may vary considerably due to internal control algorithms.</p> <p>-----</p>

Test modes:	<ul style="list-style-type: none"> • Smoke: a simulated smoke generated internally using a miniature heat exchanger and a harmless liquid from the smoke capsule. • Standard Heat: to test rate-of-rise and fixed temperature heat detectors up to 90°C (194°F). • Hi-Heat: to test rate-of-rise and fixed temperature heat detectors up to 100°C (212°F). • Clearing: clean air is blown to remove previously applied smoke. • Simultaneous Testing: Smoke and Heat in combination • Sequential Testing: Heat followed by Smoke • Smoke for ASD or flat detectors: requires separate adaptor • Delayed start smoke test
Suitable detector types:	<ul style="list-style-type: none"> • Optical / photoelectric and ionisation smoke detectors. • Thermal sensors (fixed temperature or rate-of-rise). • Multi-sensors or multi-criteria detectors. • Conventional, addressable, or analogue addressable detectors of any of the above types. • ASD and flat detectors
Operating temperature range:	Unit: +5°C to 45°C (+41°F to 113°F) Charger Cradle: +5°C to 40°C (+41°F to 104°F)
Operating humidity range:	0 to 85% RH non-condensing
Storage temperature range:	-10°C to 50°C (+14°F to 122°F)
Storage humidity range:	0 to 90% RH non-condensing (up to +35°C/95°F)
Maximum operating altitude:	3,000 m
Weight (Including battery, generator & cartridge):	1.25kg with battery Gen and Cartridge 2.39kg boxed with everything
Dimensions H (including handle) x W (widest) x D:	406 x 156 x 150mm
Dimensions H (excluding handle) x W (widest) x D:	302 x 156 150mm
Cup dimensions:	Ø112mm max 38-57mm height (see 2D drawing attached)
Outer carton dimensions H x W x D:	477 x 227 x 177 mm

19.3 Support Contact

For help and support, please use contact your local service centre with your product serial number and any error code to hand.

United Kingdom
No Climb Products Ltd.
Welham Green, AL9 7JE

Tel: +44 (0) 1707 282760
Email: detector testers-connect@detector testers.com
Web: <https://detector testers.com/troubleshooting>

Americas
SDi, LLC
3535 Route 66, Building 6
Neptune, NJ 07753

Tel: 732-751-9266
Email: service@sdifire.com
Web: <https://sdifire.com/support/>

EU DECLARATION OF CONFORMITY

This declaration of conformity is issued under the sole responsibility of the manufacturer.

Manufacturer: Detectortesters (No Climb Products Limited)
163 Dixons Hill Road, Welham Green, AL9 7JE
UK Tel: +44(0) 1707 282760



Represented in the EU by: shift-consult Hubert Scherzinger
Hessenweier 9, 79108 Freiburg, DE
Tel: +49 (0) 7665 91 21 74



XTR2 Multi-Stimulus Detector Tester

Consisting of the following models*:

Testifire-XTR2-XXX Smoke and Heat detector test kit.
Testifire-XTR2-HEAD-XXX Smoke and Heat detector test head unit. Testifire-BP-XXX Lithium-Ion battery pack
Testifire-GEN-XXX/Testifire-GEN-1PK-XXX Smoke Generator Testifire-CHAK-XXX Charger Kit
TES3/TES3-3PACK/TES3-6PACK/TES3-12PACK - XXX Smoke Cartridge

* These items can be sold separately.

The above equipment is in conformity with the following Union harmonized legislations:

1. Radio Equipment Directive 2014/53/EU
2. RoHS Directive 2011/65/EU & 2015/863/EU

The conformity assessment procedure followed is as per ANNEX II of the RED

Conformity to the essential requirements of the legislation(s) have been demonstrated by using the following standards:

Art. 3.1(a) Health and Safety	EN 61010-1:2010 EN 61010-1:2010/A1:2019/AC:2019-04 EN 61010-1:2010/A1:2019 EN 50385:2017 EN 62311:2020
-------------------------------	--

Art. 3.1(b) Electromagnetic Compatibility	EN 61326-1:2021 EN 301 489-1 V.2.2.3 (2019-11) EN 301 489-3 V.2.1.1 (2019-03) EN 301 489-17 V.31.1 (2017-02) EN 302 291-2 V.1.1.1 (2005-07) EN 302-291-1 V.1.1.1 (2005-07)
---	---

Art. 3.2 Spectrum	EN 300 328 V.2.2.2 (2019-07) EN 300 330 V.2.1.1 (2017-02)
-------------------	--

RoHS	EN IEC 63000:2018
------	-------------------

This declaration is only valid when:

- The product is stored and operated under the specified condition.
- Operated by qualified personnel.
- All EMC and safety measures recommended are take care of.

A handwritten signature in black ink, appearing to read "Colin Chapman".

Colin Chapman
VP Engineering
Signed for and behalf of: Detectortesters (No Climb Products Limited)

Date of issue: 28th November 2023

Place of Signing: Welham Green, Hertfordshire, UK

Validity: Only valid if sent by Detectortesters staff. Certificate valid until July 31, 2025.

Check by contacting support@detectortesters.com

XTR2



As our policy is one of continuous improvement, details of products described within this publication are subject to change without notice. All information provided here is believed to be correct at the time of going to press. Every effort has been made to ensure the accuracy of information which is provided in good faith but nothing contained herein is intended to incorporate any representation or warranty, either express or implied or to form the basis of any legal relations between the parties hereto, additional to or in lieu of such as may be applicable to a contract of sale or purchase.